

C120270

Fundamental Tuner (27-120 GHz)

DELTA TUNERS FOR FUNDAMENTAL ON-WAFER LOAD PULL

Focus Microwaves' new delta series of electro-mechanical tuners is designed specifically for high frequency on wafer measurements. The tuner's low profile allows it to be placed within the wafer perimeter and allows for a direct connection between the probe tip and the tuner, eliminating all possible insertion loss between the DUT and the tuner. This revolutionary new tuner design enables the engineer to achieve optimum tuning range, with a tuner whose footprint and weight has been dramatically reduced.

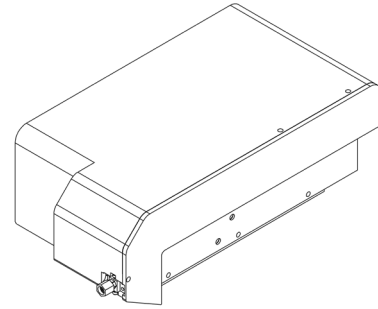

Model	Freq. Range (GHz)	Connector Type	VSWR (min)	Repeatability (min, dB/ typical, dB)	Weight (lbs)	Length (in)
C120270	27-120	1mm	≥6.5:1	-35/-40	1.85	7.764

VSWR

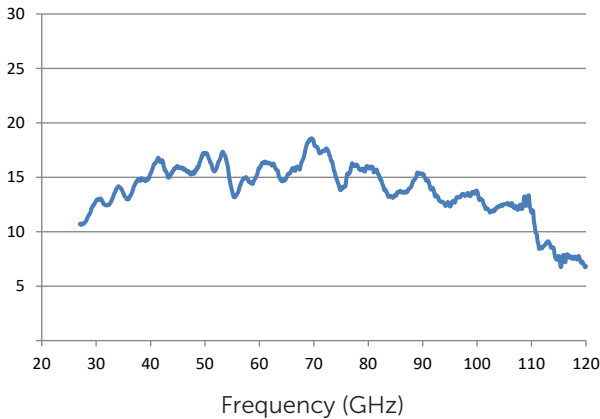

Insertion Loss (dB) (Probe withdrawn)

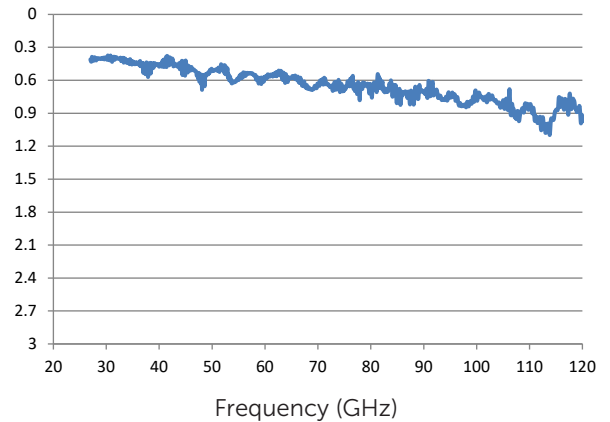

Dimensions

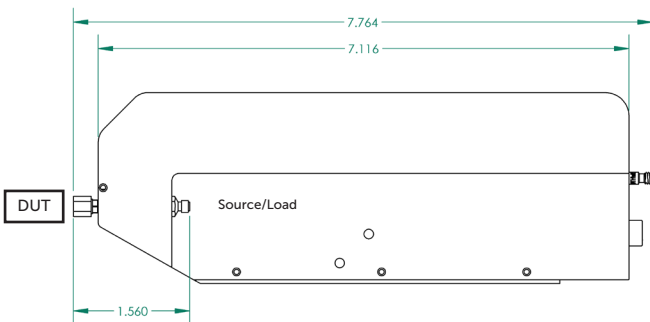

For best on-wafer operation DELTA tuners are equipped by default with male connectors DUT-side and female connectors Source/Load side. Different Configurations are possible on specific customer requests

