

# LFT008004

Low Frequency Tuner (40-80 MHz)

## General

The LFT is a unique product technology using M algorithms for low frequency wideband tuning. Three or more cascaded tuning sections use series transmission cables and parallel rotary capacitors.

The length of the cables and number of tuning sections are optimized for maximum tuning range over a given bandwidth. HLFT tuners use 6 tuning sections allowing second harmonic frequency tuning.

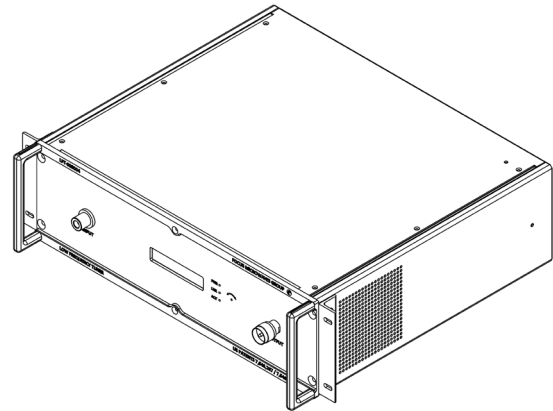

Model	Freq. Range (MHz)	Connector Type	VSWR (min/typical)	Power Handling** (W, CW)	Repeatability (min, dB/ typical, dB)	Weight (lbs)	Length (in)
LFT008004	40 - 80	N	10:1/15:1	1000	-40/-50	20.0	19.165



\*measured at F0 = 55MHz

Typical Point Distribution\*

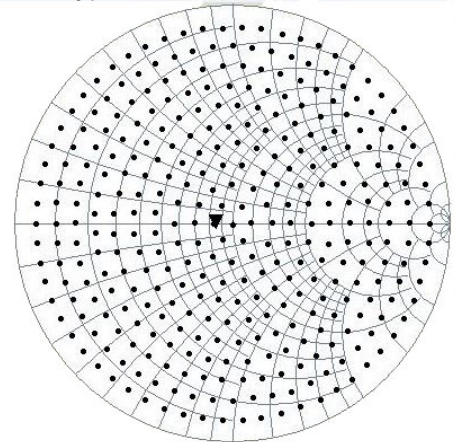

## Dimensions

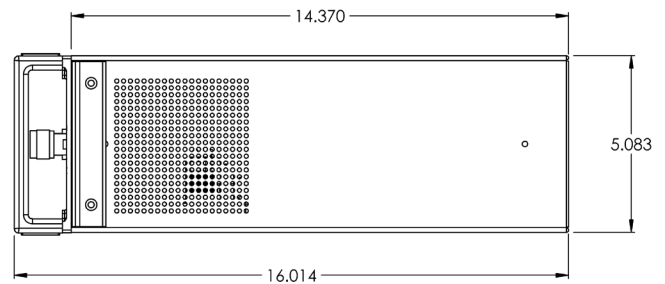
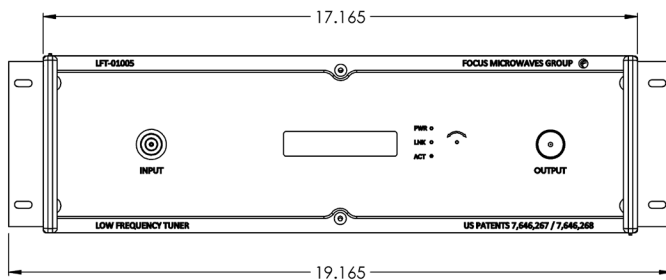

\*\*measured at 3:1 VSWR

