

HS9000 Series MULTI-CHANNEL RF SYNTHESIZERS



The Holzworth HS9000 Series multi-channel platform is designed to achieve optimal channel-to-channel stability across multiple integrated channel synthesizers via a conductively cooled, fan-less enclosure. Specific attention is paid to phase coherency between the independently controllable channels. Application specific frequency options can be configured to cover combinations up to **1 GHz, 2 GHz, 3 GHz, 4 GHz, 6 GHz, 12 GHz, and 18 GHz.**

HS9000 Series Multi-Channel RF Synthesizers

The HS9000 Series is a unique platform allowing the user to specify custom configurations for a COTS product. Units are loaded with anywhere from 1 to 8 channels, with the additional flexibility to specify each channel's frequency limits and performance options. A 16-channel narrow band configuration is also available. The result is a high performance, low phase noise, fast switching, multi-channel synthesizer that is tailored to an application with an optimal price point.

FULLY INDEPENDENT CHANNELS

Each RF output is driven by a separate, internally loaded synthesizer module. Up to 16 independently tunable synthesizers can be specified per 1U chassis allowing for the highest integrated channel density available in its class. With an average power dissipation of < 9 Watts per channel, the HS9000 series is highly efficient.

PHASE COHERENT CHANNELS

Holzworth Multi-channel RF Synthesizers offer the benefits of a proprietary NON-PLL based synthesis architecture. Coupling the NON-PLL architecture with a centralized reference distribution subsystem enables a highly phase coherent relationship across all integrated channels.

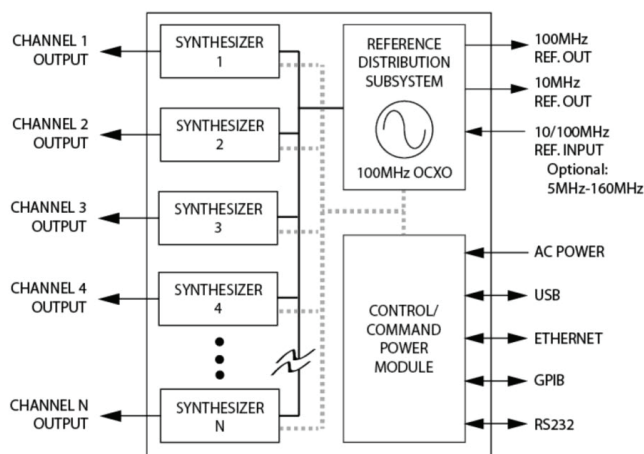

THE ULTIMATE IN CHANNEL-TO-CHANNEL STABILITY

Different from traditional PLL based synthesizers, Holzworth's proprietary architecture creates precisely synthesized signals that exhibit both instantaneous and long term stability. Temperature variations between the channels remain the only contribution to relative phase drift. The thermally optimized, fan-less chassis was specifically developed for maintaining the lowest possible thermal gradients from channel-to-channel.

Holzworth multi-channel designs are integrated into precision applications that range from ATE systems to particle accelerator timing clocks to quantum computing systems. Due to the necessity for the ultimate in signal stability, Holzworth synthesizers also come standard with thermal monitor outputs to track the relative channel temperature of each loaded channel.

HS9000 Series Multi-Channel RF Synthesizers

1 GHz/2 GHz/3 GHz/4 GHz/6 GHz FREQUENCY PERFORMANCE

The specified frequency based parameters for the HS9000 Series Multi-Channel RF Synthesizers are fully verified at final performance test and 100% guaranteed for the full warranty period of the product.

PARAMETER	MIN ¹	TYPICAL ²	MAX ¹	COMMENTS
Frequency Range				See page 5 for channel selection options
1 GHz	10 MHz		1.024 GHz	Settable from 5 MHz to 1.024 GHz
2 GHz	10 MHz		2.048 GHz	Settable from 5 MHz to 2.048 GHz
3 GHz	10 MHz		3.072 GHz	Settable from 5 MHz to 3.072 GHz
4 GHz	10 MHz		4.096 GHz	Settable from 5 MHz to 4.096 GHz
6 GHz	10 MHz		6.000 GHz	Settable from 5 MHz to 6.720 GHz
Frequency Step Size		0.001 Hz		
Phase Offset Range			+360 deg	
Phase Offset Resolution				Offset Accuracy:
10 MHz – 512 MHz		0.1 deg		±0.05 deg
512 MHz – 1.024 GHz		0.2 deg		±0.10 deg
1.024 GHz – 2.048 GHz		0.4 deg		±0.20 deg
2.048 GHz – 4.096 GHz		0.8 deg		±0.40 deg
4.096 GHz – 6.000 GHz		1.6 deg		±0.80 deg
Switching Speed (Frequency)				No additional frequency settling time
SPI Mode (ASCII)		350 µs		
SPI Mode (Binary)		200 µs		
List/Step Sweep Mode (WB)		70 µs		Wideband Mode (full bandwidth)
List/Step Sweep Mode (NB)		6 µs		Narrowband Mode (≤9% bandwidth) ³
Digital Sweep Modes				
Operating Modes				Step sweep (linear, internal) List Sweep (arbitrary list of frequency steps) Simultaneous Amplitude sweep (list)
Sweep Range	10 MHz		6.4 GHz	Limited to max frequency of model number
Dwell Time Wideband/Sweep	100 µs		10 s	1 µs increments
Dwell Time Narrowband	6 µs		10s	1 µs increments
Number of Points (STEP)	2		65535	
Number of Points (LIST)	2		3232	
Triggering				Free Run, External Trigger

¹ All MIN/ MAX performance parameters are guaranteed and 100% verified during final performance test, unless noted otherwise.

² Typical performance is "by design" and consistent with field performance data.

³ Narrowband List mode frequency limits are defined as: $F_{CENTER} \pm ((F_{CENTER} \times 0.09) / 2)$.

HS9000 Series Multi-Channel RF Synthesizers

12 GHz/18 GHz FREQUENCY PERFORMANCE

The specified frequency based parameters for the HS9000 Series Multi-Channel RF Synthesizers are fully verified at final performance test and 100% guaranteed for the full warranty period of the product.

PARAMETER	MIN ¹	TYPICAL ²	MAX ¹	COMMENTS
Frequency Range				See page 5 for channel selection options
12 GHz	100 MHz		12 GHz	VHF through X Band (settable from 10 MHz to 12.5 GHz)
18 GHz	100 MHz		18 GHz	VHF through K _u Band (settable from 10 MHz to to 20.48 GHz)
Frequency Step Size		0.001 Hz		
Phase Offset	0 deg		+360 deg	
Switching Speed (Frequency)				No additional frequency settling time
SPI Mode (ASCII)		350 μs		
SPI Mode (Binary)		200 μs		

¹ All MIN/ MAX performance parameters are guaranteed and 100% verified during final performance test, unless noted otherwise.

² Typical performance is "by design" and consistent with field performance data.

REFERENCE SPECIFICATIONS

PARAMETER	MIN ¹	TYPICAL ²	MAX ¹	COMMENTS
Internal Time Base Reference				
Adjust-to-Nominal			+/- 0.2 ppm	Uncertainty
Aging Rate		± 1 ppm/yr		1 st year. ±0.5 ppm/yr each subsequent year
Temperature Effects		≤ ±1 ppm		0 to 55 °C
10 MHz Reference Output				See plot on page 14 for measured phase noise data.
Amplitude	+2 dBm		+6 dBm	Nominal
Impedance		50 Ω		Nominal
100 MHz Reference Output				See plot on page 14 for measured phase noise data.
Amplitude	+2 dBm		+6 dBm	Nominal
Impedance		50 Ω		Nominal
External Reference Input (standard)				
Input Frequency		10/100 MHz		
Lock Range		± 4 ppm	±1 ppm	20 Hz Locking BW
External Amplitude	0 dBm		+10 dBm	
Impedance		50 Ω		50 Ω (nominal)
Waveform				Sine or Square
OPT-REFX Ext. Ref. Input (optional)³				
Input Frequency Range	5 MHz		160 MHz	Any 100 kHz increment within range
Lock Range		± 4 ppm	± 1 ppm	
External Amplitude	0 dBm		+10 dBm	
Impedance		50 Ω		
Waveform				Sine or square

¹ All MIN/ MAX performance parameters are guaranteed and 100% verified during final performance test, unless noted otherwise.

² Typical performance is "by design" and consistent with field performance data.

³ Please contact factory regarding phase noise performance when this option is fitted.

HS9000 Series Multi-Channel RF Synthesizers

CONFIGURATION GUIDE

The HS9000 Series synthesizer platform is designed to be user/application defined. Follow 4 easy steps to determine the part number with the required options.

STEP 1: SELECT TOTAL NUMBER OF CHANNELS

Select the base part number, strictly calling out the total number of channels to be loaded into the multi-channel chassis.

No. Channels	1	2	3	4	5	6	7	8
Part Number	HS9001B	HS9002B	HS9003B	HS9004B	HS9005B	HS9006B	HS9007B	HS9008B

STEP 2: SELECT CHANNEL FREQUENCY OPTIONS

Select any combination of channel frequency options. Note that the total number of channels specified here must equal the number of channels selected under STEP 1.

Frequency Range	Number of Channels per Frequency Range							
	1x	2x	3x	4x	5x	6x	7x	8x
CMOS 10 MHz - 500 MHz¹	OPT-CMOS1	OPT-CMOS2	OPT-CMOS3	OPT-CMOS4	NA	NA	NA	NA
10 MHz - 1 GHz	OPT-A1	OPT-A2	OPT-A3	OPT-A4	OPT-A5	OPT-A6	OPT-A7	OPT-A8
10 MHz - 2 GHz	OPT-B1	OPT-B2	OPT-B3	OPT-B4	OPT-B5	OPT-B6	OPT-B7	OPT-B8
10 MHz - 3 GHz	OPT-C1	OPT-C2	OPT-C3	OPT-C4	OPT-C5	OPT-C6	OPT-C7	OPT-C8
10 MHz - 4 GHz	OPT-D1	OPT-D2	OPT-D3	OPT-D4	OPT-D5	OPT-D6	OPT-D7	OPT-D8
10 MHz - 6 GHz	OPT-E1	OPT-E2	OPT-E3	OPT-E4	OPT-E5	OPT-E6	OPT-E7	OPT-E8
100 MHz - 12 GHz¹	OPT-X1	OPT-X2	OPT-X3	OPT-X4	NA	NA	NA	NA
100 MHz - 18 GHz¹	OPT-F1	OPT-F2	OPT-F3	OPT-F4	NA	NA	NA	NA

¹ These frequency ranges occupy two channel spaces.

STEP 3: SELECT OPTIONS AND ACCESSORIES

The options listed in this section are available for the multi-channel platform to comply with application specific requirements.

TYPE	Part Number	Description
OPTION ¹	OPT-EXTMOD-n	Channel dedicated, external modulation input. n= 1, 2, 3, etc. >6, contact factory
OPTION	OPT-REFX	5 MHz-160 MHz Reference Input Capability (100kHz Increments)
ACCESSORY	RACK-1U	19" Rack Mount Bracket Kit, 90° rear bracket
ACCESSORY	RACK2-1U	19" Rack Mount Bracket Kit, straight rear bracket

¹ Not available with OPT-0709-n.

PART NUMBER EXAMPLE

Ordering a 5-channel synthesizer with 1x CMOS channel, 1x 3 GHz channel, 2x 6 GHz channels, and 1x 12 GHz channel would result in the following configuration:

	Part Number	Description
	HS9005B	5ch, Multi-Channel RF Synthesizer
Options	OPT-CMOS1	1x CMOS Channel
	OPT-C1	1x 3 GHz Channel
	OPT-E2	2x 6 GHz Channels
	OPT-X1	1x 12 GHz Channel

HS9000 Series Multi-Channel RF Synthesizers

1 GHz/2 GHz/3 GHz/4 GHz/6 GHz AMPLITUDE PERFORMANCE

The specified amplitude based parameters for the HS9000 Series Multi-Channel RF Synthesizers are fully verified at final performance test and 100% guaranteed for the full warranty period of the product.

PARAMETER	MIN ¹	TYPICAL ²	MAX ¹	COMMENTS
Output Power (Calibrated)	-50 dBm		+18 dBm	Settable from -90 dBm to +25 dBm
Absolute Level Accuracy				20 °C to 30 °C (ambient temperature)
10 MHz ≤ f ≤ 6 GHz +18 to +15 dBm		± 0.35 dB	± 1.00 dB	
10 MHz ≤ f ≤ 6 GHz < +15 to > -10 dBm		± 0.25 dB	± 0.65 dB	
10 MHz ≤ f ≤ 6 GHz -10 to -50 dBm		± 0.50 dB	± 1.50 dB	
Resolution		0.01 dB		
Connector		50 Ω		SMA
VSWR (S₂₂)				
10 MHz ≤ f < 2 GHz		1.33 (-17 dB)		
2 GHz ≤ f < 4.1 GHz		1.57 (-13 dB)		
4.1 ≤ f ≤ 6.0 GHz		2.32 (-8 dB)		
Maximum Reverse Power				
Max DC Voltage	25 VDC maximum by design.			*** Some applications may require reverse power protection.
> 10 MHz	10 mW (+16dBm) max by design.			
Switching Speed (Amplitude)				Settled within 10% of set value
SPI Mode		200 μs		
List / Step Sweep Mode		1 μs		
SSB Phase Noise				See plot on page 9 for measured data.
100 MHz, 10 kHz offset		≤ -147 dBc/Hz	≤ -141 dBc/Hz	
500 MHz, 10 kHz offset		≤ -138 dBc/Hz	≤ -132 dBc/Hz	
1.0 GHz, 10 kHz offset		≤ -132 dBc/Hz	≤ -126 dBc/Hz	
2.0 GHz, 10 kHz offset		≤ -126 dBc/Hz	≤ -120 dBc/Hz	
3.0 GHz, 10 kHz offset		≤ -122 dBc/Hz	≤ -116 dBc/Hz	
4.0 GHz, 10 kHz offset		≤ -120 dBc/Hz	≤ -114 dBc/Hz	
6.0 GHz, 10 kHz offset		≤ -116 dBc/Hz	≤ -110 dBc/Hz	
Harmonics (CW mode)		(2ND / 3RD)	(2nd / 3rd)	See plot on page 8 for measured data.
100 MHz to 1.024 GHz		-42 / -56 dBc	-36 / -50 dBc	@ 0 dBm
>1.024 GHz to 4.096 GHz		-38 / -48 dBc	-32 / -42 dBc	@ 0 dBm
>4.096 GHz to 6.0 GHz		-45 / -43 dBc	-40 / -40 dBc	@ 0 dBm
Sub-Harmonics (CW mode)		(1/2 / 3/2)	(1/2 / 3/2)	See plot on page 8 for measured data.
10 MHz to 1.024 GHz		-75 / -70 dBc	-69 / 64 dBc	@ 0 dBm
>1.024 GHz to 4.096 GHz		-60 / -50 dBc	-54 / -45 dBc	@ 0 dBm
>4.096 GHz to 6.0 GHz		-53 / -62 dBc	-50 / -56 dBc	@ 0 dBm
Non-Harmonics/Broadband Spurious (CW mode)				
10 MHz to 2 GHz		-63 dBc	-60 dBc	@ 0 dBm
>2 GHz to 4.096 GHz		-52 dBc	-50 dBc	@ 0 dBm
>4.096 GHz to 6.0 GHz		-49 dBc	-45 dBc	@ 0 dBm

¹ All MIN/ MAX performance parameters are guaranteed and 100% verified during final performance test, unless noted otherwise.

² Typical performance is "by design" and consistent with field performance data.

HS9000 Series Multi-Channel RF Synthesizers

1 GHz/2 GHz/3 GHz/4 GHz/6 GHz MAXIMUM OUTPUT POWER

MAXIMUM OUTPUT POWER

The data shown here represents typical unleveled performance.

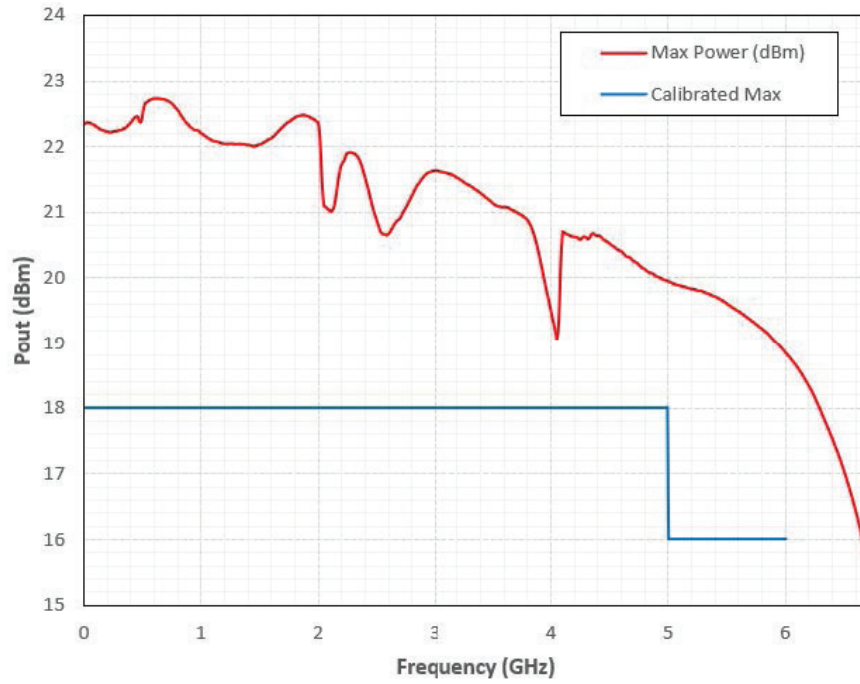

HS9000 Series Multi-Channel RF Synthesizers

1 GHz/2 GHz/3 GHz/4 GHz/6 GHz HARMONICS AND SUB-HARMONICS

HARMONICS

Harmonic data taken at 0 dBm carrier power level

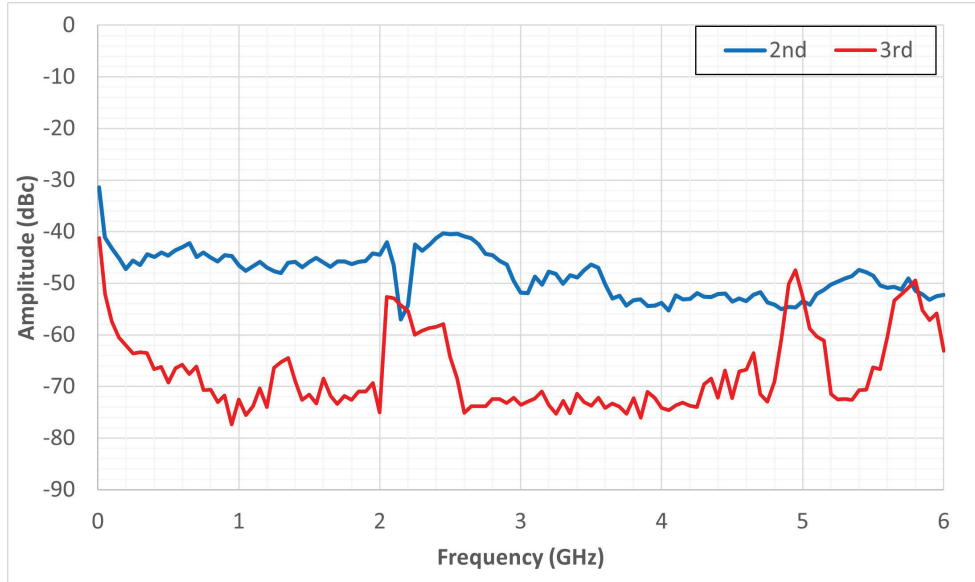

SUB-HARMONICS

Sub-harmonic data taken at 0 dBm carrier power level

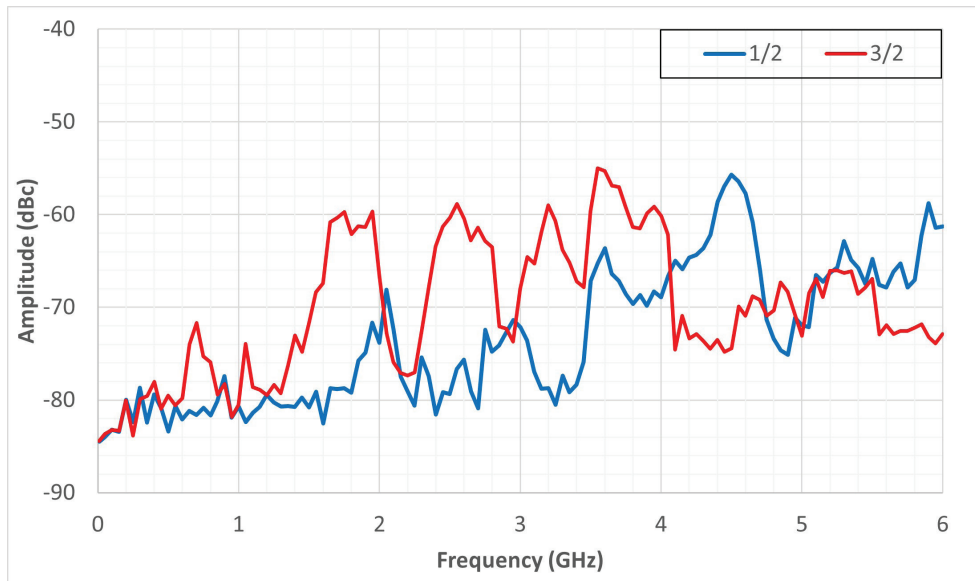

HS9000 Series Multi-Channel RF Synthesizers

1 GHz/2 GHz/3 GHz/4 GHz/6 GHz PHASE NOISE PERFORMANCE

PHASE NOISE PERFORMANCE

(Pout = +10 dBm)

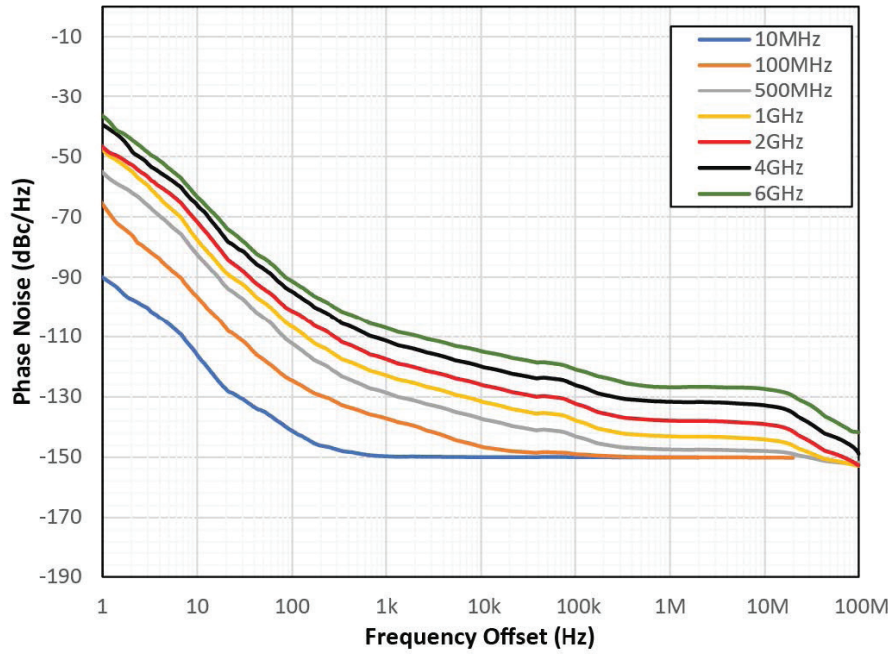

HS9000 Series Multi-Channel RF Synthesizers

12 GHz/18 GHz AMPLITUDE PERFORMANCE

The specified amplitude based parameters for the HS9000 Series Multi-Channel RF Synthesizers are fully verified at final performance test and 100% guaranteed for the full warranty period of the product.

PARAMETER	MIN ¹	TYPICAL ²	MAX ¹	COMMENTS
Output Power (Calibrated) 100 MHz to 10 GHz 10 GHz to 18 GHz	-10 dBm -10 dBm		+18 dBm +16 dBm	Settable -30 to +23 dBm
Absolute Level Accuracy 100 MHz - 10 GHz -10 dBm to 0 dBm > 0 dBm to < +14 dBm +14 dBm to +18 dBm 10 GHz - 18 GHz -10 dBm to 0 dBm > 0 dBm to < +10 dBm +10 dBm to +16 dBm			± 3.0 dB ± 1.5 dB ± 2.0 dB ± 3.0 dB ± 1.5 dB ± 2.5 dB	20 °C to 30 °C (ambient temperature)
Resolution		0.01 dB		
Connector		50 Ω		SMA
SWR (S₂₂) 100 MHz < f ≤ 6 GHz 6 GHz < f ≤ 18 GHz		1.33 (-17.0 dB) 1.43 (-15.0 dB)		Measured Measured
Maximum Reverse Power Max DC Voltage > 100 MHz		25 V _{DC} maximum by design. 16 dBm max by design.		*** Some applications may require reverse power protection.
Switching Speed (Amplitude) SPI Mode (Binary)		200 μs		Settled within 10% of set value
SSB Phase Noise 2.0 GHz, 10 kHz offset 4.0 GHz, 10 kHz offset 8.0 GHz, 10 kHz offset 12.0 GHz, 10 kHz offset 18.0 GHz, 10 kHz offset		-125 dBc/Hz -119 dBc/Hz -113 dBc/Hz -110 dBc/Hz -106 dBc/Hz	≤ -119 dBc/Hz ≤ -113 dBc/Hz ≤ -107 dBc/Hz ≤ -104 dBc/Hz ≤ -100 dBc/Hz	See plot on page 13 for measured data.
Harmonics (CW mode) 500 MHz to 5 GHz >5 GHz to 10 GHz >10 GHz to 18 GHz		(2ND / 3RD) -30 / -50 dBc -25 / -45 dBc -20 / -40 dBc	(2ND / 3RD) -25 / -45 dBc -20 / -40 dBc -15 / -35 dBc	See plot on page 12 for measured data. @ 0 dBm @ 0 dBm @ 0 dBm 3rd harmonic level, nominal only above 16 GHz
Sub-Harmonics (CW mode) 100 MHz to 3 GHz >3 GHz to 13 GHz >13 GHz to 18 GHz		(1/2 / 3/2) -60 / -55 dBc -44 / -60 dBc -40 / -48 dBc	(1/2 / 3/2) -54 / -49 dBc -38 / -54 dBc -35 / -45 dBc	See plot on page 12 for measured data. @ 0 dBm @ 0 dBm @ 0 dBm
Non-Harmonics/Broadband Spurious (CW mode) 100 MHz to 4 GHz >4 GHz to 8 GHz >8 GHz to 16 GHz >16 GHz to 18GHz		-65 dBc -50 dBc -40 dBc -35 dBc	-59 dBc -44 dBc -35 dBc -30 dBc	@ 0 dBm @ 0 dBm @ 0 dBm @ 0 dBm
Jitter (RMS) 3 GHz 6 GHz 18 GHz		85 fs 89 fs 130 fs		5 kHz < BW < 20 MHz

¹ All MIN/ MAX performance parameters are guaranteed and 100% verified during final performance test, unless noted otherwise.

² Typical performance is "by design" and consistent with field performance data.

HS9000 Series Multi-Channel RF Synthesizers

12 GHz/18 GHz MAXIMUM OUTPUT POWER

MAXIMUM OUTPUT POWER

The data shown here represents typical unleveled performance.

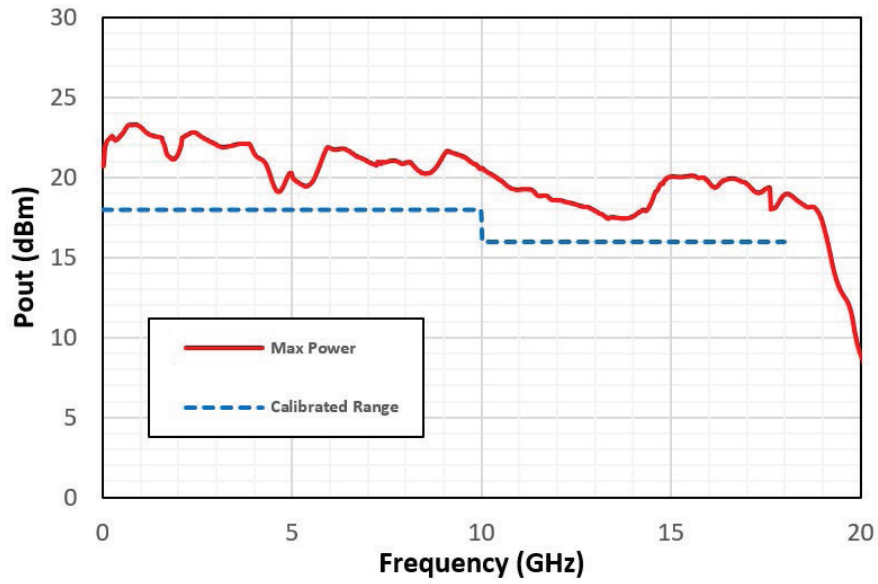

HS9000 Series Multi-Channel RF Synthesizers

12 GHz/18 GHz HARMONICS AND SUB-HARMONICS

HARMONICS

Harmonic data taken at 0 dBm carrier power level

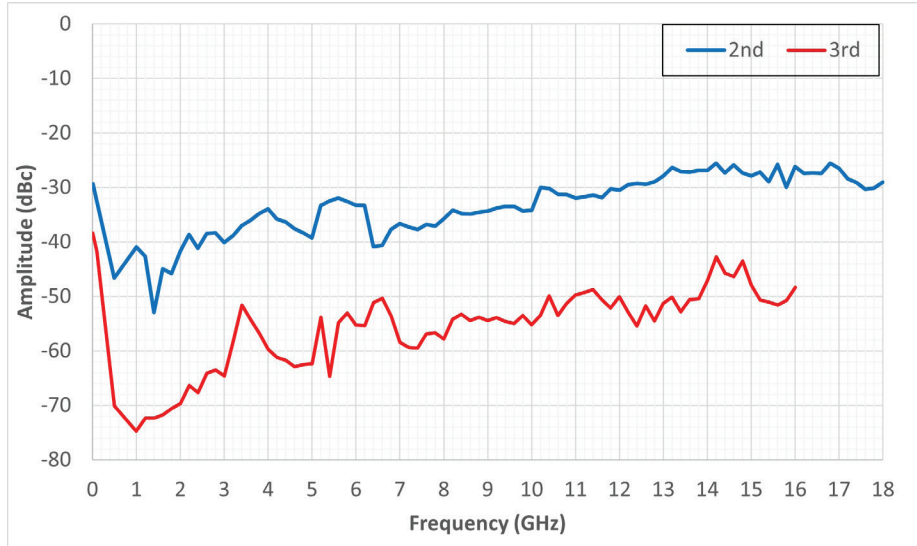

SUB-HARMONICS

Sub-harmonic data taken at 0 dBm carrier power level

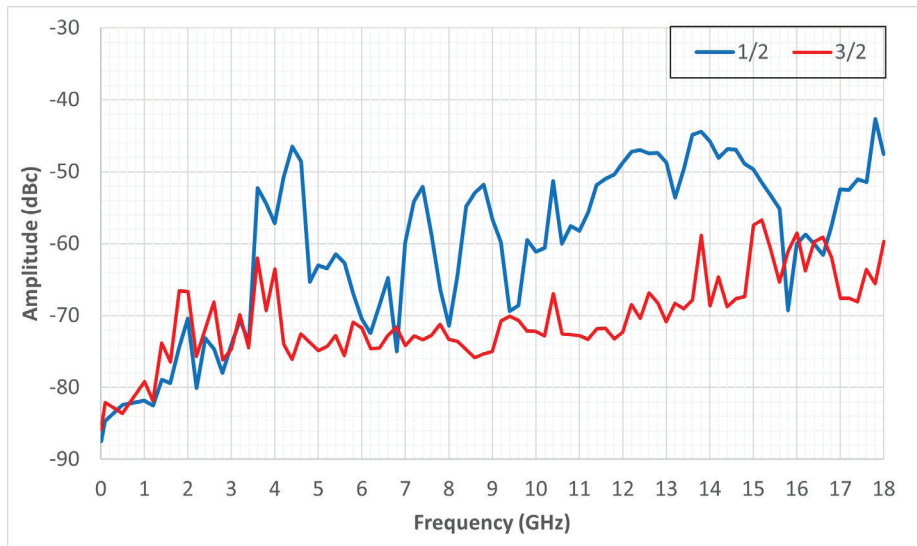

HS9000 Series Multi-Channel RF Synthesizers

12 GHz/18 GHz PHASE NOISE PERFORMANCE

PHASE NOISE PERFORMANCE

(Pout = +10 dBm)

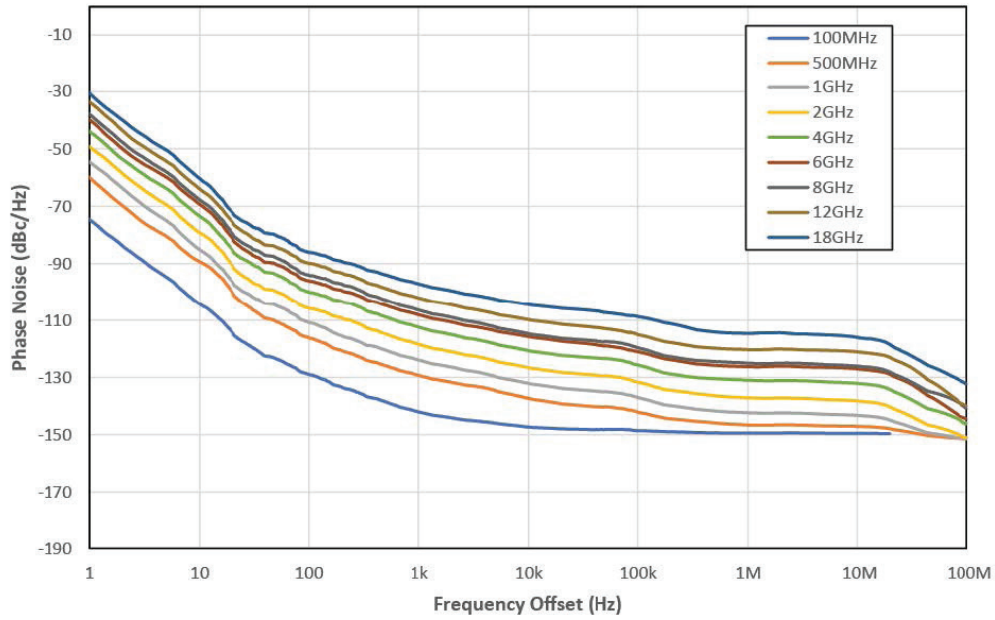

HS9000 Series Multi-Channel RF Synthesizers

REFERENCE PHASE NOISE PERFORMANCE

The HS9000 Series synthesizers come equipped with fixed 10 MHz and 100 MHz reference outputs. The fixed reference output signals are derived directly from the internal reference standard (100 MHz OCXO).

10 MHz REFERENCE OUTPUT SSB PHASE NOISE

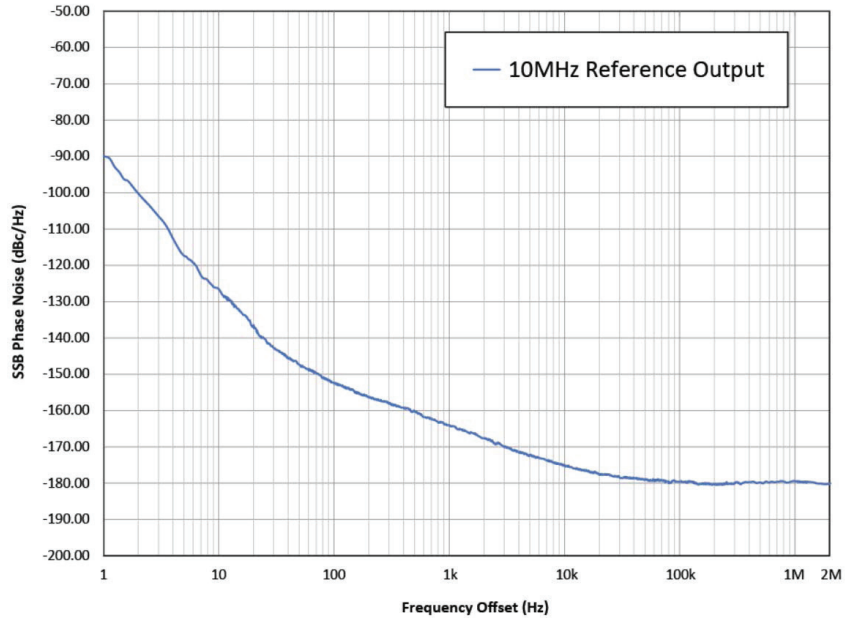

100 MHz Reference Output SSB Phase Noise

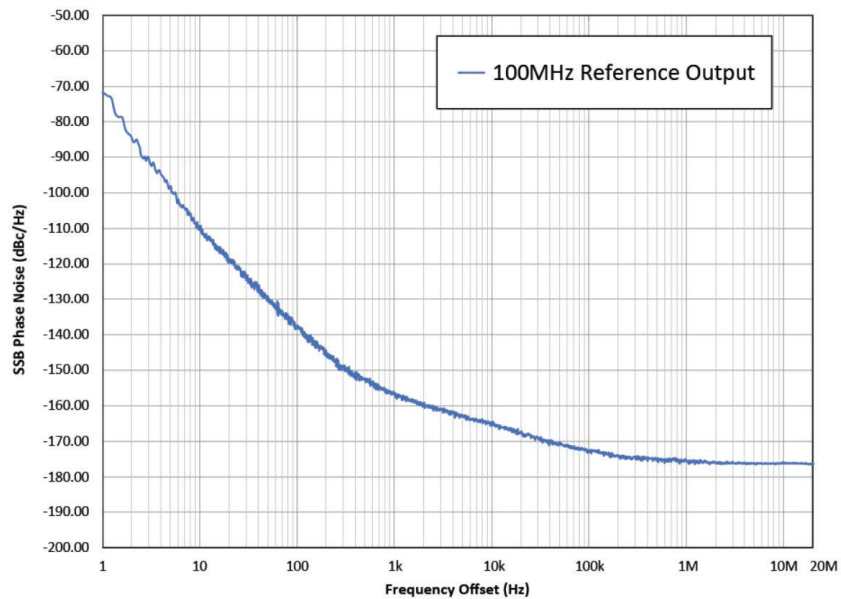

HS9000 Series Multi-Channel RF Synthesizers

ELECTRICAL SPECIFICATIONS - MODULATION

The external stimulus modulation parameters are only available on units equipped with option OPT-EXTMOD. Units with OPT-EXTMOD have channel dedicated modulation input ports installed.

EXTERNAL MODULATION

PARAMETER	PERFORMANCE ¹	COMMENTS
FREQUENCY MODULATION (Analog) Only available for channels \leq 6 GHz.		
Max Deviation	100 kHz	
Resolution	0.01% or 1 mHz, whichever is greater	
Deviation Accuracy	$< \pm 2\%$	
Modulation Freq. Response	DC to 20 kHz (-3 dB)	DC Coupled
Sensitivity when using Ext. Input	± 1 V peak into 50 Ω	+ 1V: Maximum Positive Deviation 0V: Zero Deviation from Carrier - 1V: Maximum Negative Deviation
PHASE MODULATION (Analog) Only available for channel \leq 6 GHz.		
Max Deviation	± 1.6 deg to ± 180 deg	
Frequency Response	DC to 20 kHz (-3 dB)	DC Coupled
Resolution	Frequency Dependent	See Phase Offset Specification
Sensitivity when using Ext. Input	± 1 V peak into 50 Ω	+ 1V: Maximum Positive Deviation 0V: Zero Deviation from Carrier - 1V: Maximum Negative Deviation
AMPLITUDE MODULATION (Analog) Only available for channels \leq 6 GHz.		
AM Depth Type	Linear	
Depth	5% to 75%	0.45 dB to 12 dB
Maximum Resolution	$< 3\%$ of Maximum Depth	
Depth Accuracy	5% of Maximum Depth	
Modulation Rate	DC to 10 kHz (-3 dB)	DC Coupled
Sensitivity when using Ext. Input	± 1 V peak for indicated Depth (into 50 Ω)	+ 1V: Maximum Amplitude 0V: 50% of Maximum Depth - 1V: Maximum Depth
PULSE MODULATION (Analog) Available for all channel frequencies.		
Risetime (T_r)	< 100 ns	
Falltime (T_f)	< 100 ns	
On/Off Ratio	> 70 dB	
Minimum Pulse Width	1 μ s	
ALC Loop Deviation (ALC disabled)	1 dB difference from ALC enabled	

¹ Nominal

PARAMETER	PERFORMANCE ¹	COMMENTS
External Trigger Threshold	+1.2 V	$\pm 5\%$ into 50 Ω

¹ Nominal

HS9000 Series Multi-Channel RF Synthesizers

MODULATION PERFORMANCE (Self Pulse) Only available for channels \leq 6 GHz.

HSM series synthesizers are capable of operating in self pulse modulation mode, which does not require an external stimulus signal.

PARAMETER	PERFORMANCE ¹	COMMENTS
PULSE MODULATION (Analog)		
Risetime (Tr)		
fc < 512 MHz	10 ns	
fc > 512 MHz	35 ns	
Falltime (Tf)		
fc < 512 MHz	8 ns	
fc > 512 MHz	10 ns	
On/Off Ratio	> 70dB	
Minimum Pulse Width	50 ns	
ALC Loop Deviation (ALC disabled)	1 dB difference from ALC enabled	

¹ Nominal

² Internal pulse modulation for frequencies greater than 512 MHz will exhibit increased settling time. Contact Holzworth customer support for additional data.

HS9000 Series Multi-Channel RF Synthesizers

ENVIRONMENTAL SPECIFICATIONS

THESE MODULES ARE DESIGNED FOR INDOOR USE ONLY

Environmental specifications are based on component margins, thermal verification testing and current draw tests. Production unit performance is not verified over temperature.

PARAMETER	MIN ¹	TYPICAL ²	MAX ¹	COMMENTS
Operating Temperature	0 °C		+55 °C	
AC Power Supply				
Rated Voltage	100 VAC		240 VAC	
Voltage Range	90 VAC		264 VAC	
Rated Frequency	50 Hz		60 Hz	
Frequency Range	47 Hz		63 Hz	
Power Consumption				
Chassis Power Consumption		5 W		
Each ≤6 GHz channel		9 W		
Each 12/18 GHz channel		15 W		
Warm-Up Time		15 min	30 min	20 °C (ambient temp. dependent)

¹ All MIN/ MAX performance parameters are guaranteed and 100% verified during final performance test, unless noted otherwise.

² Typical performance is "by design" and consistent with field performance data.

DESCRIPTION	SPECIFICATION (by design)
Operating Environment	
Humidity	RH 20% to 80% at wet bulb temp. <29 °C (non-condensing)
Altitude	0 to 2,000m (0 to 6,561 feet)
Vibration	0.21 G-rms maximum, 5Hz to 500Hz
Storage (Non-Operating)	
Temperature	-10 °C to + 60 °C
Humidity	RH 20% to 80% at wet bulb temp. <40 °C (non-condensing)
Altitude	0 to 4,572m (0 to 15,000 feet)
Vibration	0.5 G-rms maximum, 5 Hz to 500 Hz

REGULATORY COMPLIANCE

CE compliance with the following European Union directives
 Low Voltage Directive EU 2014/35
 Electromagnetic Compatibility Directive (EMC) EU 2014/30
 RoHS Directive EU 2015/863, WEEE Directive EU 2012/19

HS9000 Series Multi-Channel RF Synthesizers

OPTION SPECIFICATIONS

Option OPT-CMOS is an additional channel (or channels) loaded into the multi-channel system. OPT-CMOS provides a CMOS logic output signal, which may be optimal for a system that requires square wave trigger or clock signals.

PARAMETER	MIN ¹	TYPICAL ²	MAX ¹	COMMENTS
Frequency Range	10 MHz		500 MHz	
Output Voltage (CMOS Logic)		0V - 5V		0V to 2.5V into 50Ω
Phase Noise				
10 MHz, 10 kHz Offset		-152 dBc/Hz	-145 dBc/Hz	
19.2 MHz, 10 kHz Offset		-154 dBc/Hz	-145 dBc/Hz	
100 MHz, 10 kHz Offset		-152 dBc/Hz	-143 dBc/Hz	
200 MHz, 10 kHz Offset		-146 dBc/Hz	-135 dBc/Hz	
Rise Time / Fall Time (Tr/ Tf)		900 ps		
Output Impedance		50Ω		

¹ All MIN/ MAX performance parameters are guaranteed and 100% verified during final performance test, unless noted otherwise.

² Typical performance is "by design" and consistent with field performance data.

OPTION OPT-CMOS PHASE NOISE PERFORMANCE

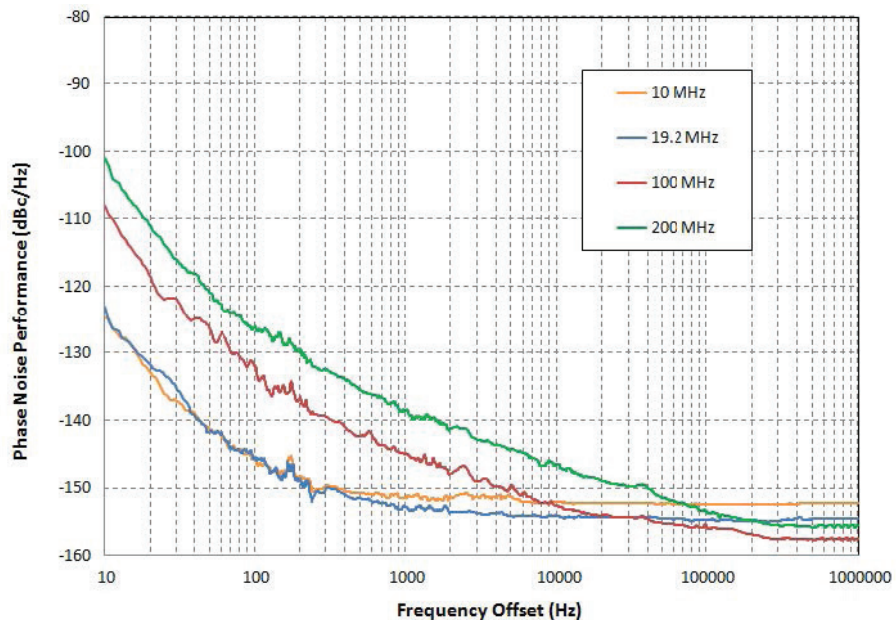

HS9000 Series Multi-Channel RF Synthesizers

HS9000B SERIES OPT-0709-n SPECIFICATIONS

The electrical performance outlined within this section covers the details for the HS9000B Series option: OPT-0709-n. This version of the HS9000B has been designed specifically to address quantum computing applications offering higher channel density for the narrower application-specific frequency range.

FREQUENCY PERFORMANCE

PARAMETER	MIN ¹	TYPICAL ²	MAX ¹	COMMENTS
Number of Outputs (per 1U chassis)	2		16	Independently tunable channels.
Frequency Range	7 GHz		9 GHz	
Frequency Resolution	0.001 Hz			
Internal Time Base Reference (Oscillator Aging Rate)		± 1 ppm/yr		1 st year. ±0.5 ppm/yr each subsequent year
Temperature Effects		± 1 ppm		0 to 55 °C
Internal Time Base Reference Adjust-to-Nominal Aging Rate Temperature Effects		± 1 ppm/yr ≤ ± 1 ppm	+/- 0.2 ppm	Uncertainty 1 st year. ±0.5 ppm/yr each subsequent year 0 to 55 °C
Reference Output Frequency Amplitude Impedance	+4 dBm	100 MHz 50 Ω		Nominal Nominal
External Reference Input (standard) Input Frequency Lock Range External Amplitude Impedance Waveform	0 dBm	10/100 MHz ± 4 ppm 50 Ω	+15 dBm	10 MHz or Internal 100 MHz Ref. 2 Hz Locking BW 50 Ω (nominal) Sine or Square

AMPLITUDE PERFORMANCE

PARAMETER	MIN ¹	TYPICAL ²	MAX ¹	COMMENTS
Output Power	0 dBm		+10 dBm	Independently tunable channels
Resolution		0.01 dB		Independently tunable channels
Maximum Reverse Power Max DC Voltage > 100 kHz	25 VDC maximum by design. 10 mW (10 dBm) max by design.			
Switching Speed (Amplitude)	5 ms maximum by design. Settling to within 0.1 dB.			
Absolute Level Accuracy		± 0.10 dB	± 0.5 dB	20 °C to 30 °C (ambient temperature)
SSB Phase Noise 7.0 GHz, 10 kHz offset 8.0 GHz, 10 kHz offset 9.0 GHz, 10 kHz offset		-111 dBc/Hz -111 dBc/Hz -111 dBc/Hz	≤ -108 dBc/Hz ≤ -108 dBc/Hz ≤ -108 dBc/Hz	
Harmonics		-30 dBc	-20 dBc	
Sub-Harmonics 7000 MHz ≤ f ≤ 7500 MHz 7500 MHz < f ≤ 9000 MHz		-45 dBc -60 dBc	-35 dBc -50 dBc	
Non-Harmonics / Spurious		-48 dBc	-38 dBc	

¹ All MIN/ MAX performance parameters are guaranteed and 100% verified during final performance test, unless noted otherwise.

² Typical performance is "by design" and consistent with field performance data.

HS9000 Series Multi-Channel RF Synthesizers

HS9000B SERIES OPT-0709-n CONFIGURATION GUIDE

The HS9000 Series synthesizer platform is designed to be user/application defined. Follow three easy steps to determine the part number with the required options.

STEP 1: SELECT TOTAL NUMBER OF CHANNELS

Select the base part number, strictly calling out the total number of channels to be loaded into the multi-channel chassis. Channels are available in multiples of two up to a maximum of 16.

No. Channels	2	4	6	8	10	12	14	16
Part Number	HS9002B	HS9004B	HS9006B	HS9008B	HS9010B	HS9012B	HS9014B	HS9016B

STEP 2: SELECT CHANNEL FREQUENCY OPTIONS

Select the channel frequency option. Note that the total number of channels specified here must equal the number of channels selected under STEP 1.

Frequency Range	2x	4x	6x	8x	10x	12x	14x	16x
7 GHz 9 GHz	OPT-0709-2	OPT-0709-4	OPT-0709-6	OPT-0709-8	OPT-0709-10	OPT-0709-12	OPT-0709-14	OPT-0709-16

STEP 3: SELECT OPTIONS AND ACCESSORIES

The options listed in this section are available for the multi-channel platform to comply with application specific requirements.

TYPE	Part Number	Description
OPTION	OPT-REFX	160 MHz Reference Input Capability (100 kHz Increments)
ACCESSORY	RACK-1U	19" Rack Mount Bracket Kit, 90° rear bracket
ACCESSORY	RACK2-1U	19" Rack Mount Bracket Kit, straight rear bracket

PART NUMBER EXAMPLE

Ordering a 16-channel 7 GHz – 9 GHz synthesizer would result in the following configuration:

		Description
Part Number	HS9016B	16 ch, Multi-Channel RF Synthesizer
Options	OPT-0709-16	16x 7 GHz to 9 GHz Channels



HS9000 Series Multi-Channel RF Synthesizers

MECHANICAL CONFIGURATION

The HS9000 Series comes in a 1U high, rack mountable chassis. The example shown is of a 6 channel unit (front panel configuration may vary). A universal rack mount bracket kit is an available accessory (Part No.: RACK-1U or RACK2-1U). Mechanical dimensions are listed in inches (and millimeters).

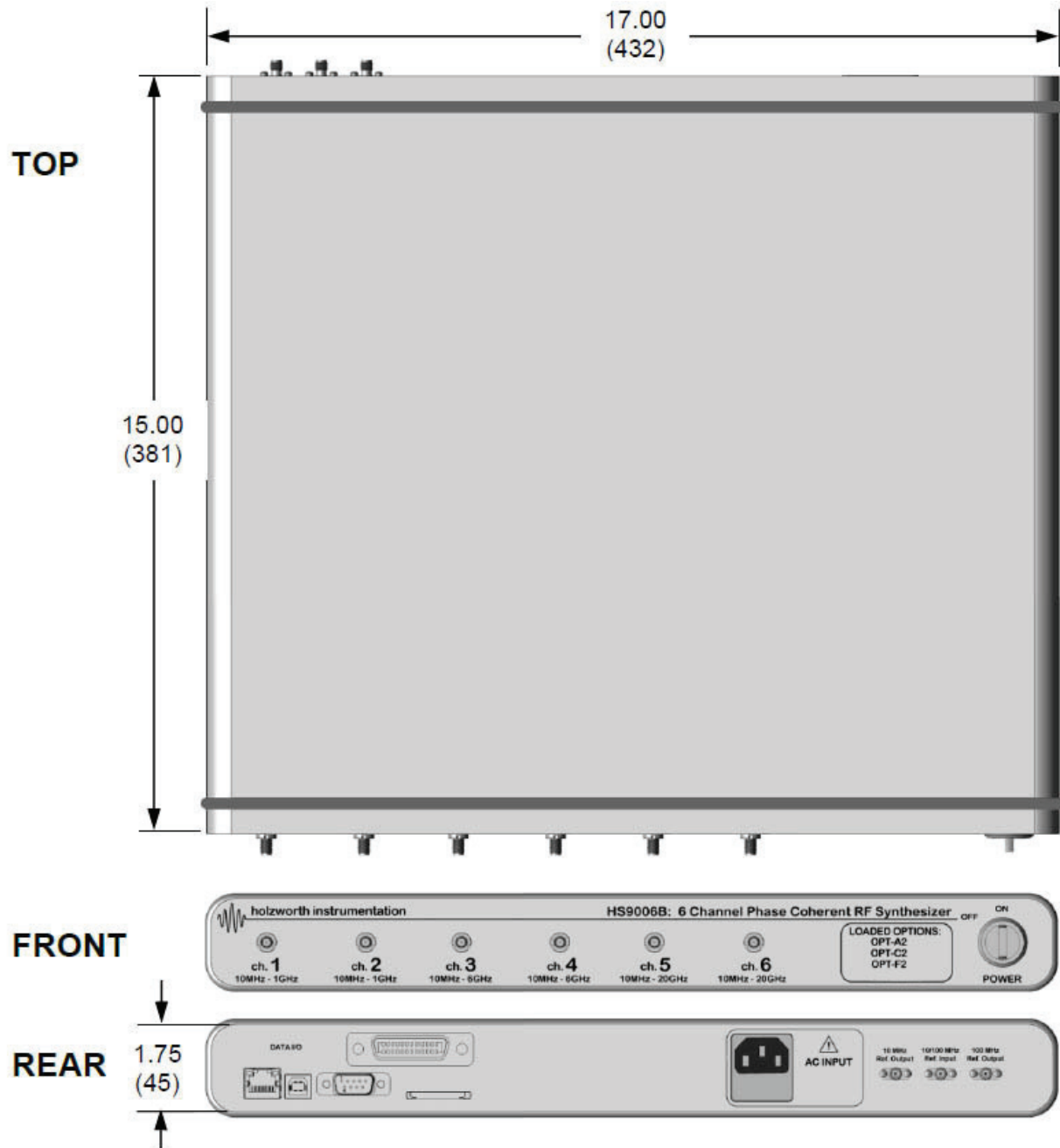

HS9000 Series Multi-Channel RF Synthesizers

CONNECTORS and PHYSICAL SPECIFICATIONS

FRONT PANEL

DESCRIPTION	CONFIGURATION
RF Output Connector Type	SMA Jack. 1-8 Output Ports, dependent on loaded options. 50 ohm.
Modulation Input(s)	SMA Jack. 1-6 Output Ports, dependent on loaded options. 50 ohm.

REAR PANEL

DESCRIPTION	CONFIGURATION
100 MHz Reference Output	SMA Jack. 50 ohm.
10 MHz Reference Output	SMA Jack. 50 ohm.
Reference Input Port	SMA Jack. 50 ohm.
AC Power Input AC Input Rating	IEC 320-C13 90-260 V _{AC} , 47-63 Hz. Specify country at time of order for proper power cord.
Data I/O Interface Connectivity Storage	USB (B-Type), Ethernet, RS-232, GPIB SD Card Reader

PHYSICAL

DESCRIPTION	1U high, 19" rack mount: 15in x 17in x 1.75in (381mm x 431.8mm x 44.5mm)
CONFIGURATION	25 lb (10.9 kilograms) MAXIMUM

INCLUDED HARDWARE AND CERTIFICATIONS

Each product delivery includes specific, standard hardware and certifications.

DESCRIPTION
HS9000 SERIES SYNTHESIZER
AC Power Cord (7 ft/2.1 m) ¹
Ethernet Cable (10 ft/3 m)
USB Cable (6 ft/1.8 m)
CALIBRATION CERTIFICATION

¹ Specify final country of destination for shipment with proper power cord.

HS9000 Series Multi-Channel RF Synthesizers

INTERFACE GUI

The HS9000 Series hardware utilizes a virtual front panel as the command/control interface. Each unit comes with an open license to operate the application on any standard PC, including those equipped with touch screen monitors. The analyzer operates under the HID (Human Interface Device) protocol, which means there are no drivers to install. The C++ based application GUI compliments the driver free instrument by being extremely reliable. The open DLL can also be directly accessed for control of the unit via MATLAB™, LabVIEW™, C++ code, Visual Basic, etc.



HS9000B SERIES MAIN CONTROL WINDOW

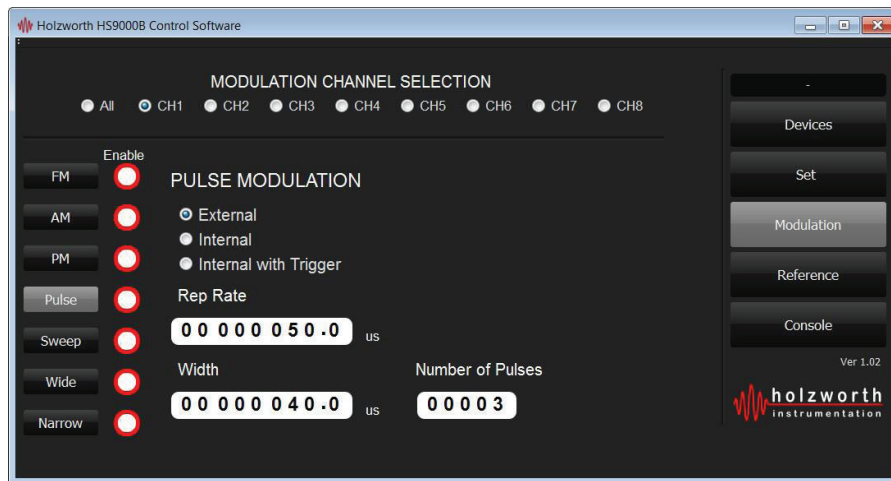

HS9000B SERIES MODULATION CONTROL WINDOW

HS9000 Series Multi-Channel RF Synthesizers

WARRANTY

All Holzworth HS9000 Series synthesizer products come with a standard 3 year 100% product warranty covering manufacturing defects. All product repairs and maintenance must be performed by Holzworth Instrumentation. Holzworth reserves the right to invalidate the warranty for any products that have been tampered with or used improperly. Refer to Holzworth Terms & Conditions of Sales for more details.

Holzworth products are proudly designed and assembled in the USA.

CONTACT INFORMATION

Contact Holzworth directly for a product quotation, a product demonstration, or for technical inquiries.

Holzworth Instrumentation Sales Support

Phone: +1.303.325.3473

Holzworth Instrumentation Technical Support

Phone: +1.303.325.3473

Email: support@holzworth.com