

HSY9000A Series

ULTRA LOW PHASE NOISE
MULTI-CHANNEL
RF SYNTHESIZERS



The HSY9000 Series RF synthesizers offer industry-leading phase noise and spectral purity performance as a multi-channel CW signal source. The compact 1U chassis allows for anywhere from 1 to 2 independently tunable channels (frequency / phase offset / amplitude) to optimize channel density within test system racks where real estate is limited. Application specific frequency options can be configured to cover combinations of 10 MHz to **3 GHz, 6 GHz, 12 GHz, and 20 GHz**. Each broadband channel output provides an accurate dynamic range of up to +18 dBm to -110 dBm. Holzworth's unique multi-loop architecture provides the ultimate in frequency accuracy, channel-to-channel stability, and phase coherency.

HSY9000 Series Multi-Channel RF Synthesizers

PHASE COHERENT CHANNELS: 3 GHz–6 GHz–12 GHz–20 GHz



FULLY INDEPENDENT CHANNELS

Each RF output is driven by a separate, internally loaded synthesizer/attenuator module. Up to 2 independently tunable synthesizers can be specified per 1U chassis allowing for the highest integrated channel density available in its class.

PHASE COHERENT CHANNELS

Holzworth HSY9000 Series RF synthesizers offer the performance benefits of a proprietary YIG-based, multi-loop architecture with a centralized reference distribution subsystem, which maintains a tight phase coherent relationship across all integrated channels.

THE ULTIMATE IN CHANNEL-TO-CHANNEL STABILITY

Different from traditional PLL-based synthesizers, Holzworth's proprietary multi-loop architecture creates precisely synthesized signals that exhibit both instantaneous and long-term stability. Temperature variations between the channels remain the only contribution to drift. The thermally optimized, fan-less chassis was specifically developed for maintaining the lowest possible thermal gradients from channel-to-channel. Channel specific thermal monitoring is available for tracking the relative channel temperature of each loaded synthesizer module.

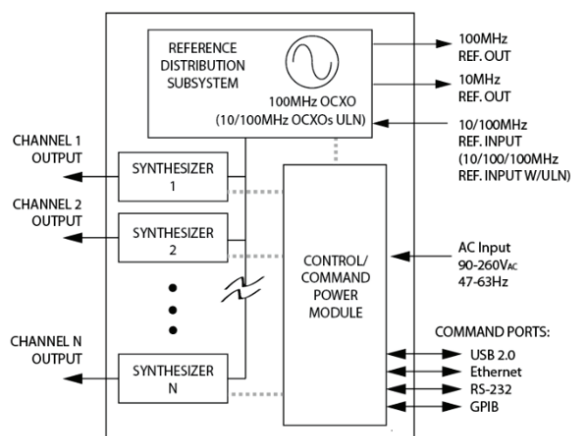

HSY9000 Series Multi-Channel RF Synthesizers

FREQUENCY PERFORMANCE

The specified frequency performance parameters for the HSY9000 Series multi-channel RF synthesizers are fully verified at final performance test and 100% guaranteed for the full warranty period of the product.

PARAMETER	MIN ¹	TYPICAL ²	MAX ¹	COMMENTS
Frequency Range	10 MHz 10 MHz 50 MHz 50 MHz		3 GHz 6 GHz 12 GHz 20 GHz	See page 5 for channel selection options
Switching Speed		50 ms	60 ms	
Frequency Step Size		0.001 Hz		
Phase Offset Resolution		0.1 °		Baseband 1.5 GHz to 3.0 GHz MHz (N=1) 0.05 ° ±0.05 °
Phase Offset Range		0 to 359.88°, f > 1500 MHz		
Internal Timebase Reference Adjust-to-Nominal Aging Rate Temperature Effects		± 1 ppm/yr ≤ ± 1 ppm	+/- 0.2 ppm	Uncertainty 1st year. ±0.5 ppm/yr each subsequent year 0 to 55 °C
10 MHz Reference Output Amplitude Impedance	+2 dBm	50 Ω	+6 dBm	Nominal Nominal
100 MHz Reference Output Amplitude Impedance	+2 dBm	50 Ω	+6 dBm	Nominal Nominal
External Reference Input (standard) Input Frequency Lock Range External Amplitude Impedance Waveform	0 dBm	10/100 MHz ± 4 ppm 50 Ω	+10 dBm	Nominal Sine or square
OPT-ULN Ext. Ref. Input (optional) Input Frequency Range Lock Range External Amplitude Impedance Waveform		10/100/1000 MHz ± 0.5 ppm +10 dBm 50 Ω		Nominal Nominal Sine or square

¹ All MIN/ MAX (Minimum/ Maximum) performance parameters are guaranteed and 100% verified during final performance test.

² Typical performance is "by design" and consistent with field performance data.

HSY9000 Series Multi-Channel RF Synthesizers

HSY9000 SERIES CONFIGURATION GUIDE

The HSY9000 Series synthesizer platform is designed to be user/application defined. Follow four easy steps to determine the part number with the required options.

STEP 1: SELECT TOTAL NUMBER OF CHANNELS

Select the base part number, strictly calling out the total number of channels to be loaded into the multi-channel chassis.

No. Channels	1	2*
Part Number	HSY9001A	HSY9002A

* Active cooling is required in multi-channel configurations. The cooling must be sufficient to keep channel internal temperatures below 60 °C. Internal channel temperatures of each channel can be monitored with the using the "CHx:TEMP?" command to monitor each channel or ":TEMP?" for an average of each channel.

STEP 2: SELECT CHANNEL FREQUENCY OPTIONS

Select any combination of channel frequency options. Note that the total number of channels specified here must equal the number of channels selected under STEP 1.

Frequency Range	Number of Channels per Frequency Range	
	1x	2x
10 MHz – 3 GHz	OPT-103-Y	OPT-203-Y
10 MHz – 6 GHz	OPT-106-Y	OPT-206-Y
50 MHz – 12 GHz	OPT-112-Y	OPT-212-Y
50 MHz – 20GHz	OPT-120-Y	OPT-220-Y

STEP 3: SELECT OPTIONS AND ACCESSORIES

TYPE	Part Number	Description
OPTION	OPT-ULN	Ultra-Low Noise: improves close-in phase noise (offsets up to ≤ 100 Hz) and expands external reference options to include 1000 MHz
ACCESSORY	RACK-1U	19" Rack Mount Bracket Kit, 90° rear bracket, 24 in max. depth
ACCESSORY	RACK2-1U	19" Rack Mount Bracket Kit, straight rear bracket, 24 in max. depth
ACCESSORY	RACK-1U-L	19" Rack Mount Bracket Kit, 90° rear bracket, 29 in max. depth
ACCESSORY	RACK2-1U-L	19" Rack Mount Bracket Kit, straight rear bracket, 29 in max. depth
ACCESSORY	CASE-1U	Carrying/storage case

PART NUMBER EXAMPLE

Ordering a 2 channel HSY9000 synthesizer with 1x 10 MHz - 6 GHz channel and 1x 50 MHz - 12 GHz channel would result in the following configuration:

Part Number	Description
HSY9002A	2 channel HSY9000 RF Synthesizer
Options	
OPT-106-Y	1x 6 GHz Channel
OPT-112-Y	1x 12 GHz Channel

HSY9000 Series Multi-Channel RF Synthesizers

3 GHz / 6 GHz AMPLITUDE PERFORMANCE

This section contains performance specifications and data for OPT-n03-Y (3 GHz) and OPT-n06-Y (6 GHz) channels. The specified parameters for the HSY9000 Series multi-channel RF synthesizers are fully verified at final performance test and 100% guaranteed for the full warranty period of the product.

PARAMETER	MIN ¹	TYPICAL ²	MAX ¹	COMMENTS		
Output Power (Calibrated) 10 MHz ≤ f ≤ 200 MHz 200 MHz < f ≤ 5.0 GHz 5.0 GHz < f ≤ 6.0 GHz	-110 dBm -110 dBm -110 dBm		+15 dBm +18 dBm +16 dBm	Settable from -115 dBm to +20 dBm		
Maximum Output Power (unleveled) 10 MHz ≤ f ≤ 6.0 GHz		See plot on page 6				
Resolution		0.01 dB				
Connector		50 Ω		SMA (Jack)		
Switching Speed		5 ms				
Absolute Level Accuracy 10 MHz ≤ f ≤ 6.0 GHz	MAX to +10 dBm +10 to -10 dBm -10 to -60 dBm < -60 dBm		± 1.0 dB ± 0.7 dB ± 1.0 dB ± 1.3 dB	35 °C to 45 °C case temperature		
SSB Phase Noise f _c : Output +10 dBm	1 Hz	Offset (typical) 10 kHz	1 MHz	1 Hz	Offset (max) 10 kHz	1 MHz
10 MHz	≤ -92 dBc/Hz	≤ -162 dBc/Hz	≤ -163 dBc/Hz	≤ -86 dBc/Hz	≤ -156 dBc/Hz	≤ -157 dBc/Hz
100 MHz	≤ -73 dBc/Hz	≤ -152 dBc/Hz	≤ -160 dBc/Hz	≤ -67 dBc/Hz	≤ -146 dBc/Hz	≤ -154 dBc/Hz
500 MHz	≤ -58 dBc/Hz	≤ -144 dBc/Hz	≤ -158 dBc/Hz	≤ -52 dBc/Hz	≤ -138 dBc/Hz	≤ -152 dBc/Hz
1 GHz	≤ -51 dBc/Hz	≤ -140 dBc/Hz	≤ -157 dBc/Hz	≤ -45 dBc/Hz	≤ -134 dBc/Hz	≤ -151 dBc/Hz
3 GHz	≤ -42 dBc/Hz	≤ -131 dBc/Hz	≤ -151 dBc/Hz	≤ -36 dBc/Hz	≤ -125 dBc/Hz	≤ -145 dBc/Hz
6 GHz	≤ -36 dBc/Hz	≤ -125 dBc/Hz	≤ -146 dBc/Hz	≤ -30 dBc/Hz	≤ -119 dBc/Hz	≤ -140 dBc/Hz
OPT-ULN SSB Phase Noise f _c : Output +10 dBm	1 Hz	Offset (typical) 10 kHz	1 MHz			
10 MHz	≤ -117 dBc/Hz	≤ -162 dBc/Hz	≤ -163 dBc/Hz			
100 MHz	≤ -96 dBc/Hz	≤ -153 dBc/Hz	≤ -160 dBc/Hz			
500 MHz	≤ -80 dBc/Hz	≤ -146 dBc/Hz	≤ -158 dBc/Hz			
1 GHz	≤ -69 dBc/Hz	≤ -143 dBc/Hz	≤ -157 dBc/Hz			
3 GHz	≤ -64 dBc/Hz	≤ -135 dBc/Hz	≤ -150 dBc/Hz			
6 GHz	≤ -59 dBc/Hz	≤ -130 dBc/Hz	≤ -144 dBc/Hz			
Harmonics³ 10 MHz ≤ f ≤ 6.0 GHz			(2ND / 3RD) -30 / -45 dBc			Output set to +10 dBm
Sub-Harmonics³ 10 MHz ≤ f ≤ 1.5 GHz 1.5 GHz < f ≤ 3.0 GHz 3.0 GHz < f ≤ 6.0 GHz			(1/2 / 3/2) < -80 / -90 dBc -80 / -90 dBc -84 / -92 dBc			Output set to +10 dBm
Non-Harmonics / Spurious⁴ 10 MHz ≤ f ≤ 1.5 GHz 1.5 GHz < f ≤ 6.0 GHz			-88 dBc -83 dBc			Output set to +10 dBm

¹ All MIN/ MAX (Minimum/ Maximum) performance parameters are guaranteed and 100% verified during final performance test.

² Typical performance is "by design" and consistent with field performance data.

³ RBW: 1.8 kHz, VBW: 1.8 kHz, Span 1 MHz

⁴ RBW: 10 kHz, VBW: 10 kHz, Span 10 MHz

HSY9000 Series Multi-Channel RF Synthesizers

3 GHz / 6 GHz MAXIMUM OUTPUT POWER

The data shown here represents typical unleveled performance.

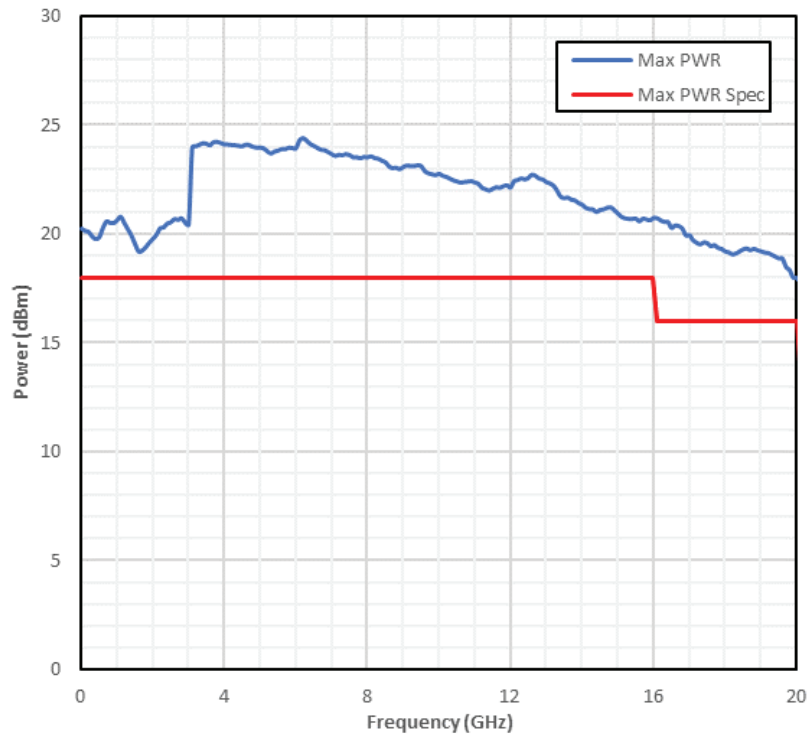

3 GHz / 6 GHz HARMONICS & SUB-HARMONICS

Harmonic and sub-harmonic data taken at +10 dBm carrier power level.

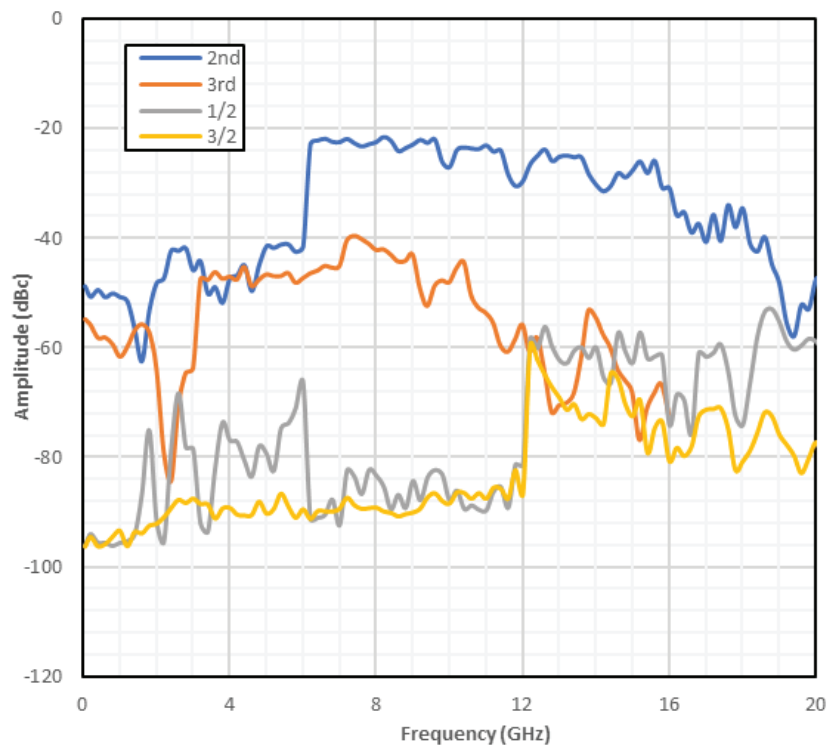

HSY9000 Series Multi-Channel RF Synthesizers

3 GHz / 6 GHz PHASE NOISE PERFORMANCE ($P_{out} = +10 \text{ dBm}$)

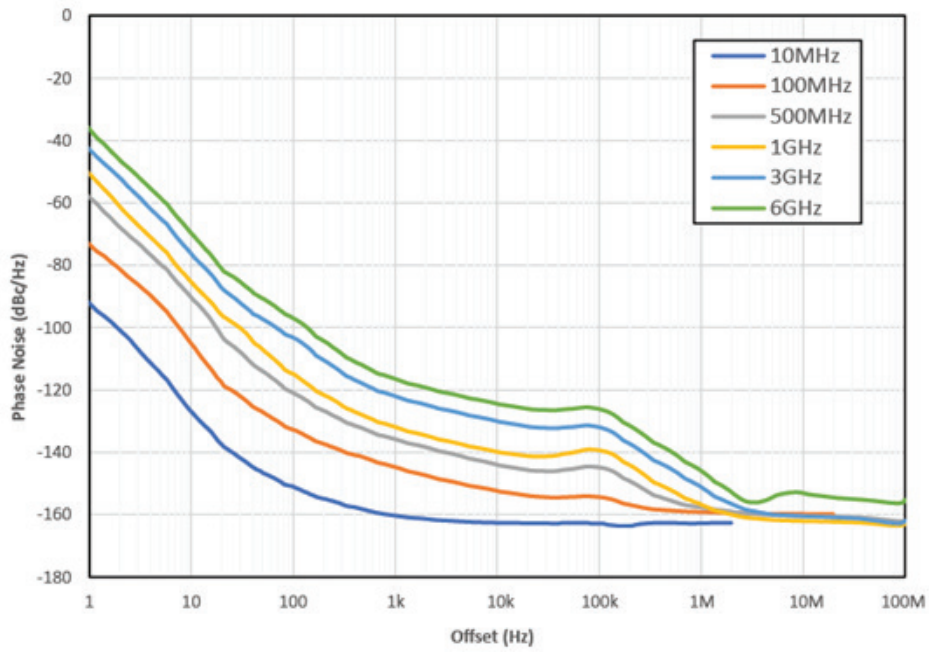

3 GHz / 6 GHz OPT-ULN PHASE NOISE PERFORMANCE ($P_{out} = +10 \text{ dBm}$)

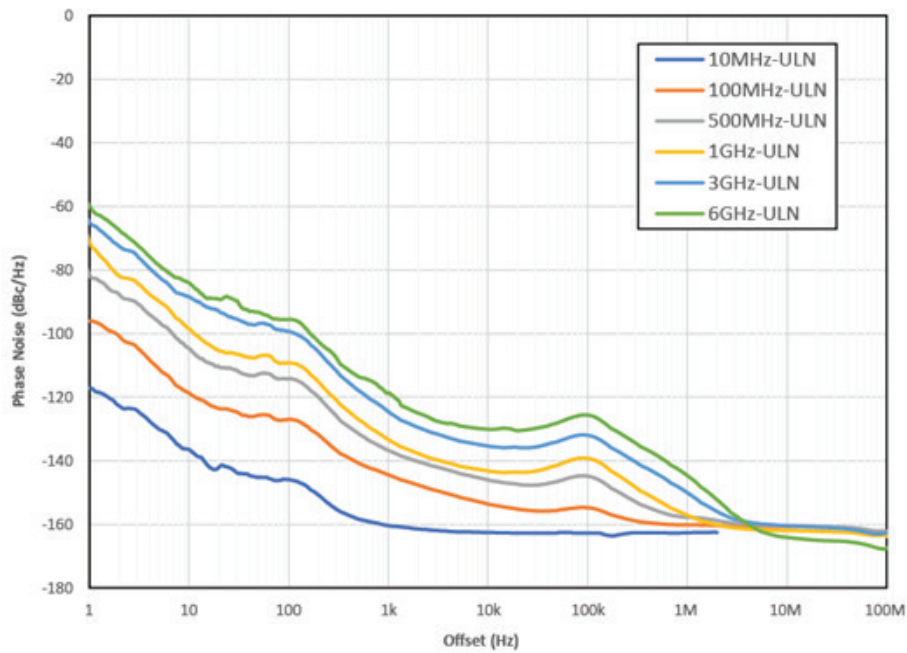

HSY9000 Series Multi-Channel RF Synthesizers

12 GHz / 20 GHz AMPLITUDE PERFORMANCE

This section contains performance specifications and data for OPT-n12 (12 GHz) and OPT-n20 (20 GHz) channels. The specified parameters for the HSY9000 Series multi-channel RF synthesizers are fully verified at final performance test and 100% guaranteed for the full warranty period of the product.

PARAMETER	MIN ¹	TYPICAL ²	MAX ¹	COMMENTS		
Output Power (Calibrated) 50 MHz ≤ f ≤ 16.0 GHz 16.0 GHz < f ≤ 20.0 GHz	-50 dBm -50 dBm		+18 dBm +16 dBm	Settable from -60 dBm to +20 dBm		
Maximum Output Power (unleveled) 50 MHz ≤ f ≤ 20.0 GHz		See plot on page 9				
Resolution		0.01 dB				
Connector		50 Ω		OPT-n12-Y: SMA (Jack) OPT-n20-Y: Super SMA (Jack)		
Switching Speed (Amplitude)		5 ms				
Absolute Level Accuracy 50 MHz ≤ f ≤ 20 GHz	MAX to +10 dBm +10 to -10 dBm -10 to -50 dBm		± 1.4 dB ± 0.7 dB ± 1.4 dB	35 °C to 45 °C case temperature		
SSB Phase Noise f _c : Output +10 dBm	1 Hz	Offset (typical) 10 kHz	1 MHz	1 Hz	Offset (max) 10 kHz	1 MHz
50 MHz	≤ -95 dBc/Hz	≤ -160 dBc/Hz	≤ -163 dBc/Hz	≤ -89 dBc/Hz	≤ -154 dBc/Hz	≤ -157 dBc/Hz
100 MHz	≤ -73 dBc/Hz	≤ -157 dBc/Hz	≤ -160 dBc/Hz	≤ -67 dBc/Hz	≤ -151 dBc/Hz	≤ -154 dBc/Hz
500 MHz	≤ -60 dBc/Hz	≤ -148 dBc/Hz	≤ -157 dBc/Hz	≤ -54 dBc/Hz	≤ -142 dBc/Hz	≤ -151 dBc/Hz
1 GHz	≤ -51 dBc/Hz	≤ -142 dBc/Hz	≤ -157 dBc/Hz	≤ -45 dBc/Hz	≤ -136 dBc/Hz	≤ -151 dBc/Hz
3 GHz	≤ -41 dBc/Hz	≤ -136 dBc/Hz	≤ -160 dBc/Hz	≤ -35 dBc/Hz	≤ -130 dBc/Hz	≤ -154 dBc/Hz
6 GHz	≤ -35 dBc/Hz	≤ -132 dBc/Hz	≤ -145 dBc/Hz	≤ -29 dBc/Hz	≤ -126 dBc/Hz	≤ -139 dBc/Hz
12 GHz	≤ -26 dBc/Hz	≤ -124 dBc/Hz	≤ -135 dBc/Hz	≤ -20 dBc/Hz	≤ -118 dBc/Hz	≤ -129 dBc/Hz
20 GHz	≤ -24 dBc/Hz	≤ -118 dBc/Hz	≤ -133 dBc/Hz	≤ -18 dBc/Hz	≤ -112 dBc/Hz	≤ -127 dBc/Hz
OPT-ULN SSB Phase Noise f _c : Output +10 dBm	1 Hz	Offset (typical) 10 kHz	1 MHz			
50 MHz	≤ -112 dBc/Hz	≤ -160 dBc/Hz	≤ -160 dBc/Hz			
100 MHz	≤ -92 dBc/Hz	≤ -155 dBc/Hz	≤ -159 dBc/Hz			
500 MHz	≤ -80 dBc/Hz	≤ -145 dBc/Hz	≤ -157 dBc/Hz			
1 GHz	≤ -73 dBc/Hz	≤ -143 dBc/Hz	≤ -157 dBc/Hz			
3 GHz	≤ -63 dBc/Hz	≤ -136 dBc/Hz	≤ -150 dBc/Hz			
6 GHz	≤ -60 dBc/Hz	≤ -135 dBc/Hz	≤ -144 dBc/Hz			
12 GHz	≤ -52 dBc/Hz	≤ -123 dBc/Hz	≤ -138 dBc/Hz			
20 GHz	≤ -48 dBc/Hz	≤ -118 dBc/Hz	≤ -132 dBc/Hz			
Harmonics³ 50 MHz ≤ f ≤ 5.0 GHz 5 GHz < f ≤ 20.0 GHz			(2ND / 3RD) -40 / -48 dBc -20 / -40 dBc	Output set to +10 dBm See plot on page 9 for measured data.		
Sub-Harmonics³ 50 MHz ≤ f ≤ 1.5 GHz 1.5 GHz < f ≤ 6.0 GHz 6.0 GHz < f ≤ 12.0 GHz 12.0 GHz < f ≤ 18.0 GHz 18.0 GHz < f ≤ 20.0 GHz			(1/2 / 3/2) < -64 / -84 dBc -64 / -84 dBc -70 / -90 dBc -70 / -88 dBc -64 / -100 dBc	Output set to +10 dBm		
Non-Harmonics / Spurious⁴ 50 MHz ≤ f ≤ 750 MHz 750 MHz < f ≤ 1.5 GHz 1.5 GHz < f ≤ 3.0 GHz 3.0 GHz < f ≤ 6.0 GHz 6.0 GHz < f ≤ 12.0 GHz 12.0 GHz < f ≤ 20.0 GHz			< -80 dBc -80 dBc -78 dBc -73 dBc -68 dBc -62 dBc	Output set to +10 dBm		

¹ All MIN/ MAX (Minimum/ Maximum) performance parameters are guaranteed and 100% verified during final performance test.

² Typical performance is "by design" and consistent with field performance data.

³ RBW: 1.8 kHz, VBW: 1.8 kHz, Span 1 MHz

⁴ RBW: 10 kHz, VBW: 10 kHz, Span 10 MHz

HSY9000 Series Multi-Channel RF Synthesizers

12 GHz / 20 GHz MAXIMUM OUTPUT POWER

The data shown here represents typical unleveled performance.

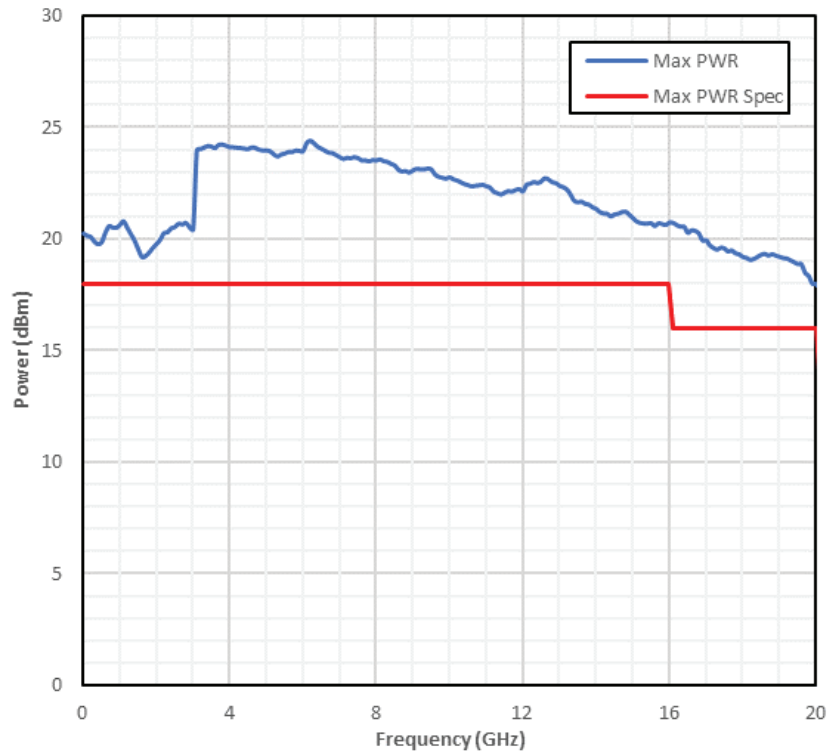

12 GHz / 20 GHz HARMONICS & SUB-HARMONICS

Harmonic and sub-harmonic data taken at +10 dBm carrier power level.

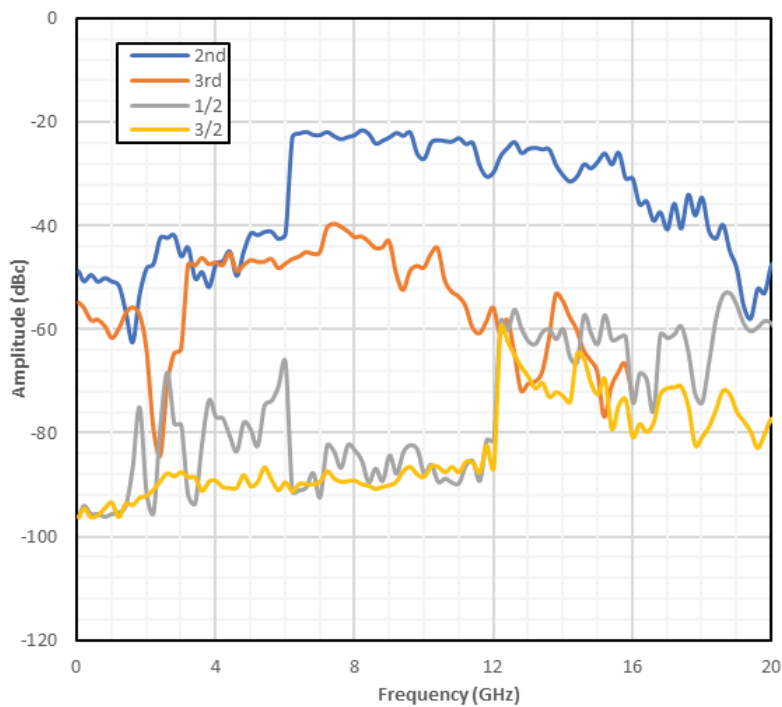

HSY9000 Series Multi-Channel RF Synthesizers

12 GHz / 20 GHz PHASE NOISE PERFORMANCE ($P_{out} = +10 \text{ dBm}$)

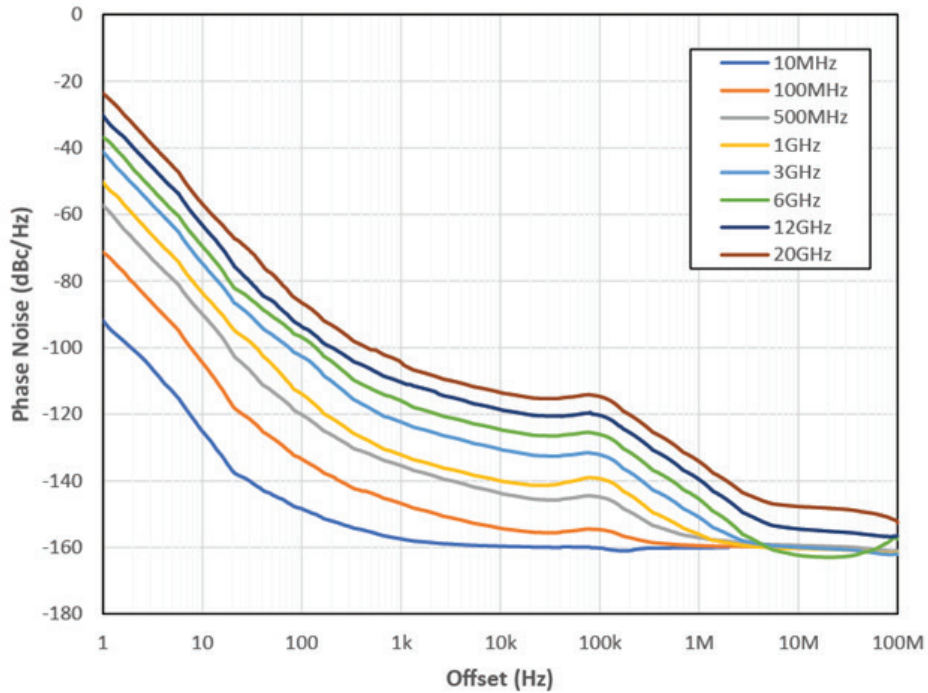

12 GHz / 20 GHz OPT-ULN PHASE NOISE PERFORMANCE ($P_{out} = +10 \text{ dBm}$)

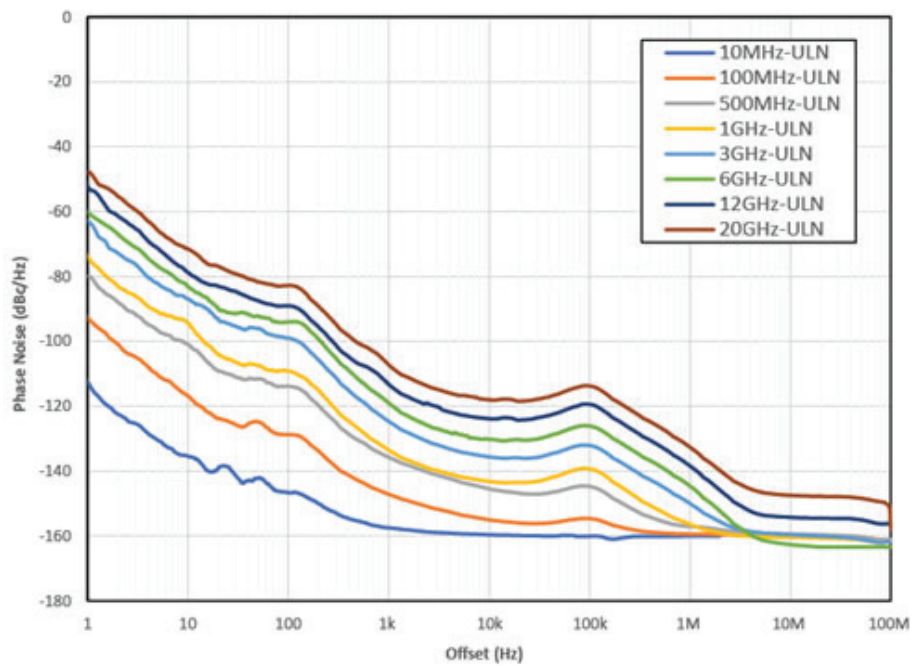

HSY9000 Series RF Synthesizers

STANDARD VS OPT-ULN REFERENCE PHASE NOISE COMPARISON ($P_{out} = +10 \text{ dBm}$)

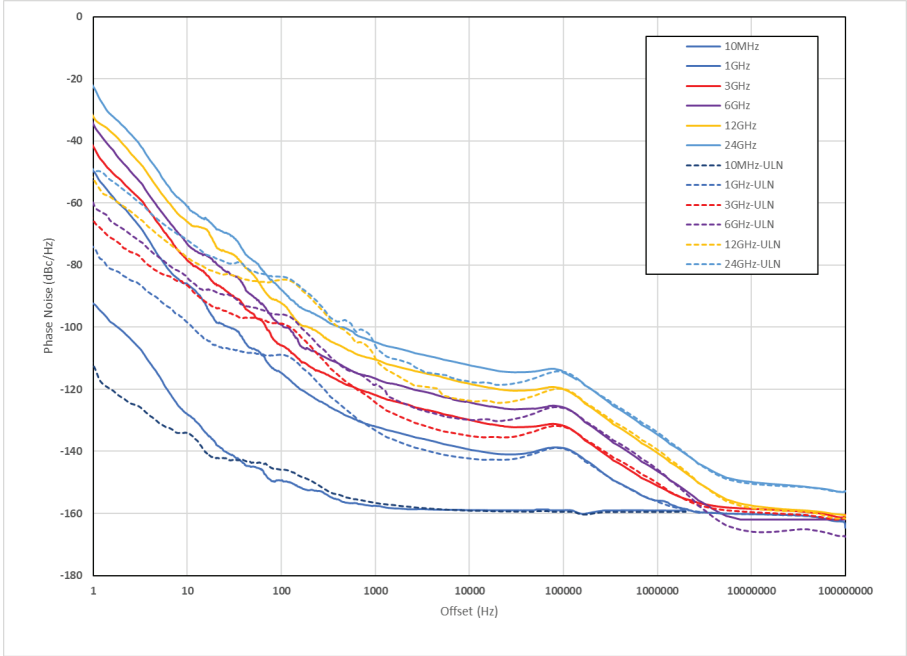

HSY9000 Series RF Synthesizers

ENVIRONMENTAL SPECIFICATIONS

THIS INSTRUMENT IS DESIGNED FOR INDOOR USE ONLY.

Environmental specifications are based on component margins, thermal verification testing and current draw tests. Production unit performance is verified at room temperature.

PARAMETER	MIN	TYPICAL ¹	MAX	COMMENTS
Operating Temperature	0 °C		+60 °C	Internal temperature
Temperature Monitor Range	-40 °C		+85 °C	Absolute, channel dedicated sensor
AC Power Supply				
Rated Voltage	100 VAC		240 VAC	
Voltage Range	90 VAC		264 VAC	
Rated Frequency	50 Hz		60 Hz	
Frequency Range	47Hz		63 Hz	
AC Power Consumption				
Chassis		14-24 W		Approximate values. May vary with loading and temperature. Chassis includes reference and communication module. HSY9002 (2 channel) Example: 14 W + (17 W * 2) = 48 W Total
3 or 6 GHz Channel (each)		17 W		
12 GHz Channel (each)		24 W		
20 GHz Channel (each)		24 W		
Warm-Up Time		10 min		20 °C (ambient temp. dependent)

¹ Typical performance is "by design" and consistent with field performance data.

DESCRIPTION	Recommended Environmental Conditions
Operating Environment	
Humidity	Relative humidity 15% to 95%, <29 °C (non-condensing)
Altitude	0 to 3,048 m (0 to 10,000 feet)
Vibration	0.21 g RMS maximum, 5 Hz to 500 Hz
Storage (Non-Operating)	
Temperature	-10 °C to + 60 °C
Humidity	Relative humidity 0% to 90%, <40 °C (non-condensing)
Altitude	0 to 15,240 m (0 to 50,000 feet)
Vibration	0.5 g RMS maximum, 5 Hz to 500 Hz

REGULATORY COMPLIANCE

CE compliance with the following European Union directives
 Low Voltage Directive EU 2014/35
 Electromagnetic Compatibility Directive (EMC) EU 2014/30
 RoHS Directive EU 2015/863, WEEE Directive EU 2012/19

HSY9000 Series Multi-Channel RF Synthesizers

MECHANICAL CONFIGURATION

The HSY9000 Series comes in a 1U high, rack mountable chassis. The example shown is of a 4-channel unit (front panel configuration may vary). A universal rack mount bracket kit is an available accessory (Part No.: RACK-1U, RACK-1U-L, RACK2-1U and RACK2-1U-L). Mechanical dimensions are listed in inches (and millimeters).

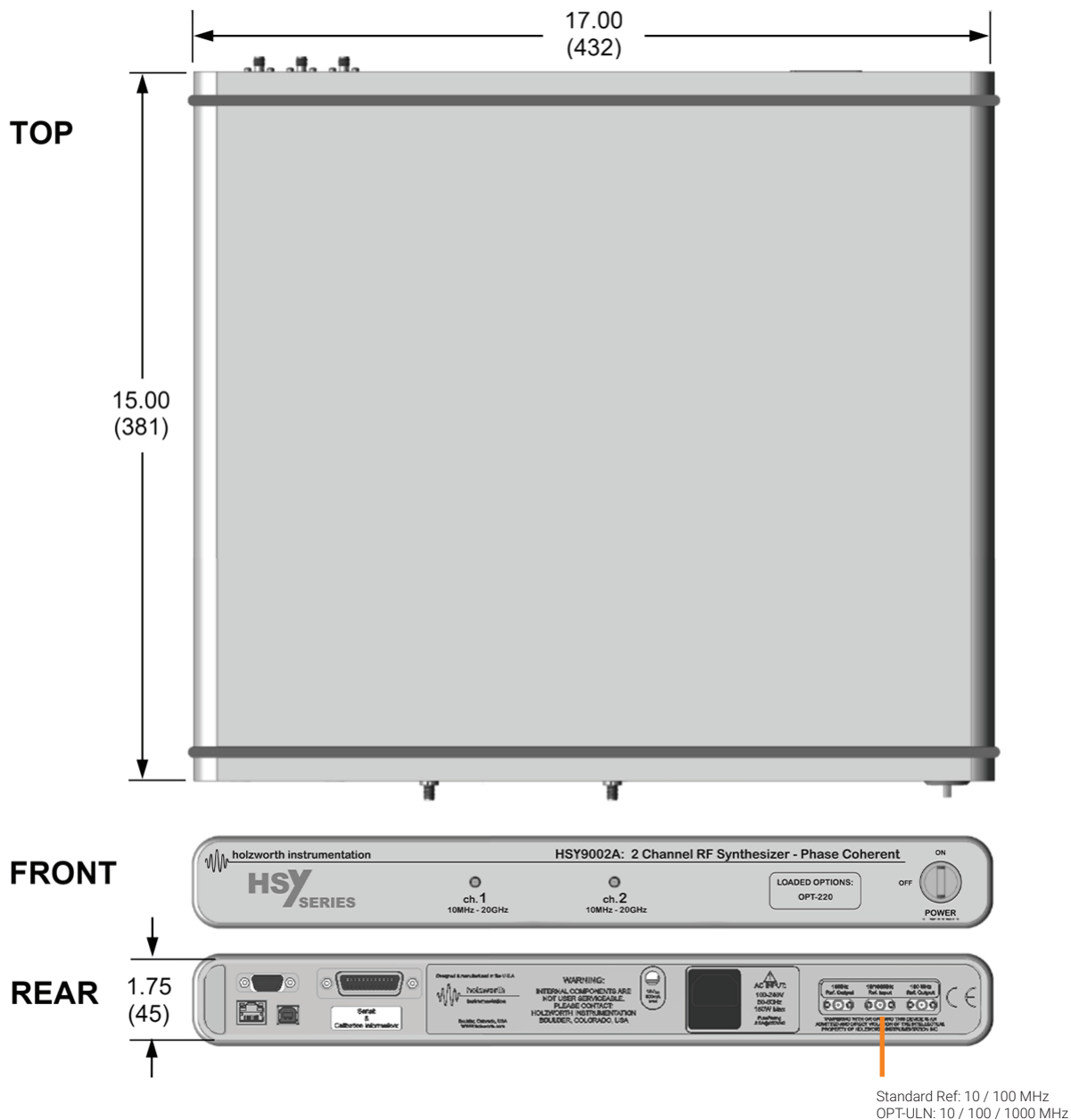

HSY9000 Series Multi-Channel RF Synthesizers

CONNECTORS and PHYSICAL SPECIFICATIONS

FULLY INDEPENDENT CHANNELS

DESCRIPTION	Configuration
RF Output(s) Connector Type	SMA-J, 50 Ω: OPT-n03-Y, OPT-n06-Y, OPT-n12-Y (n = number of channels = number of connectors) Super SMA-J, 50 Ω: OPT-n20-Y (n = number of channels = number of connectors)

REAR PANEL

DESCRIPTION	Configuration
Reference Output Port Connector Type Output Frequency Output Level Output Waveform	SMA, 50 Ω 10 MHz ±10 Hz and 100 MHz ±100 Hz +2 dBm to +6 dBm Sinusoid
Reference Input Port Connector Type Input Frequency Input Frequency (OPT-ULN) Input Level	SMA, 50 Ω 10/100 MHz 10/100/1000 MHz 0 dBm to +10 dBm (sinusoid or square)
AC Power Input Connector Type AC Input Rating	IEC 320-C13 100-240 VAC, 47-63 Hz. Specify country at time of order for proper power cord.
Data I/O Interface Connectivity	USB B-Type (virtual COM port), Ethernet, RS-232, GPIB

PHYSICAL

Dimensions (L x W x H)	1U high, 19" rack mount: 15 in x 17 in x 1.75 in (381 mm x 431.8 mm x 44.5 mm)
Weight	25 lbs. (11.34 kilograms) MAXIMUM

HSY9000 Series Multi-Channel RF Synthesizers

INCLUDED HARDWARE AND CERTIFICATIONS

Each product delivery includes following hardware and certifications.

DESCRIPTION

HSY9000 SERIES SYNTHESIZER

AC Power Cord (7 ft/2.1 m)¹

Ethernet Cable (10 ft/3 m)

USB Cable (6 ft/1.8 m)

CALIBRATION CERTIFICATION

¹ Specify final country of destination for shipment with proper power cord

HSY9000 Series Multi-Channel RF Synthesizers

INTERFACE - GUI

The HSY9000 Series hardware utilizes a virtual front panel as the control interface. Each unit comes with an open license to operate the application on any standard PC, including those equipped with touch screen monitors. The C++ based application GUI compliments the driver free instrument by being extremely reliable. The units can also be directly accessed via any data I/O interface for control via MATLAB™, LabVIEW™, C++ code, Python, VB code, etc.

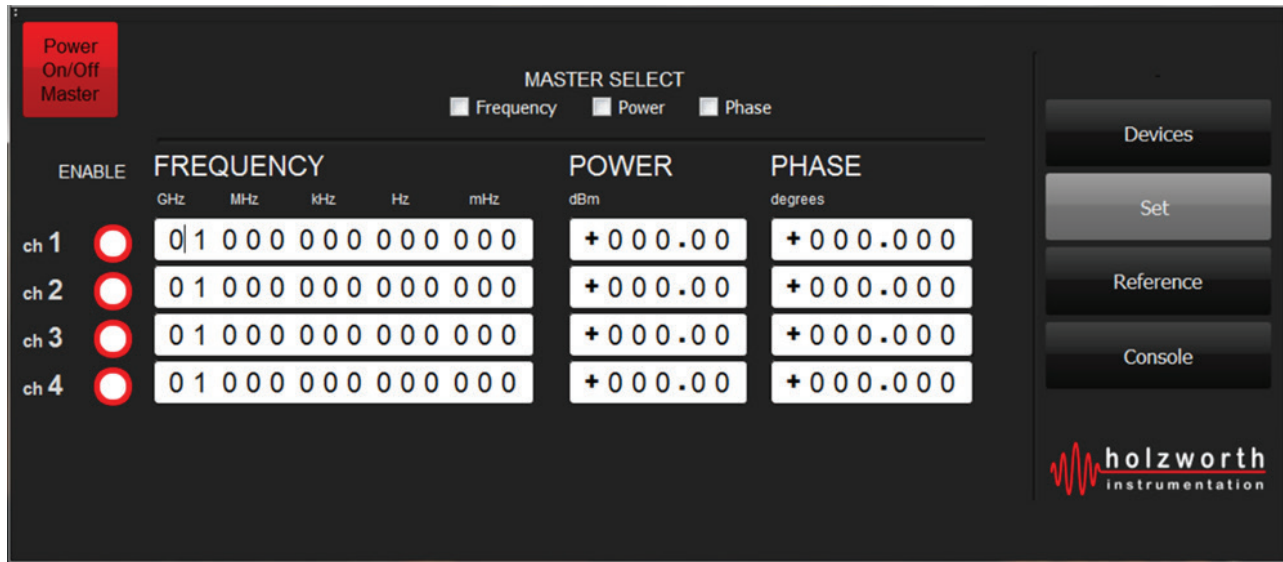



HSY9000 Series Multi-Channel RF Synthesizers

WARRANTY

All Holzworth HSY9000 Series synthesizer products come with a standard 3-year 100% product warranty covering manufacturing defects. All product repairs and maintenance must be performed by Holzworth Instrumentation. Holzworth reserves the right to invalidate the warranty for any products that have been tampered with or used improperly. Refer to Holzworth Terms & Conditions of Sales for more details.

Holzworth products are proudly designed and assembled in the USA.

CONTACT INFORMATION

Contact Holzworth directly for a product quotation, a product demonstration, or for technical inquiries.

Holzworth Instrumentation Sales Support

Phone: +1.303.325.3473

Holzworth Instrumentation Technical Support

Phone: +1.303.325.3473

Email: support@holzworth.com

Wireless Telecom Group Inc.

25 Eastmans Rd
Parsippany, NJ
United States
Tel: +1 973 386 9696
Fax: +1 973 386 9191
holzworth.com

© Copyright 2023
All rights reserved.

H/HSY Series/0623/EN
Note: Specifications, terms and conditions are subject to change without prior notice.